

vision & language

CS 685, Fall 2021

Advanced Natural Language Processing
<http://people.cs.umass.edu/~miyyer/cs685/>

Mohit Iyer

College of Information and Computer Sciences
University of Massachusetts Amherst

some slides adapted from Vicente Ordonez, Fei-Fei Li, and Jacob Andreas

Logistics stuff

- This Wed (11/3): exam review, will go over some important topics, quiz questions, prev. exam questions
- HW 1 due Friday 11/5
- No class next week, there is a pre-recorded video on commonsense reasoning that you can watch on 11/8
- No quiz this week or next week
- Exam details:
 - We'll release an Overleaf link on 11/9
 - You must type your answers (either in LaTeX or with some other word processing software)
 - Exam will be released at 8AM Thursday, due 8AM Saturday (US Eastern time) on Gradescope

image captioning



a red truck is parked on
a street lined with trees

visual question answering



- Is this truck considered “vintage”?
- Does the road look new?
- What kind of tree is behind the truck?

we've seen how to compute
representations of words and
sentences. what about images?

grayscale images are matrices



0	3	2	5	4	7	6	9	8
3	0	1	2	3	4	5	6	7
2	1	0	3	2	5	4	7	6
5	2	3	0	1	2	3	4	5
4	3	2	1	0	3	2	5	4
7	4	5	2	3	0	1	2	3
6	5	4	3	2	1	0	3	2
9	6	7	4	5	2	3	0	1
8	7	6	5	4	3	2	1	0

what range of values can each pixel take?

color images are tensors

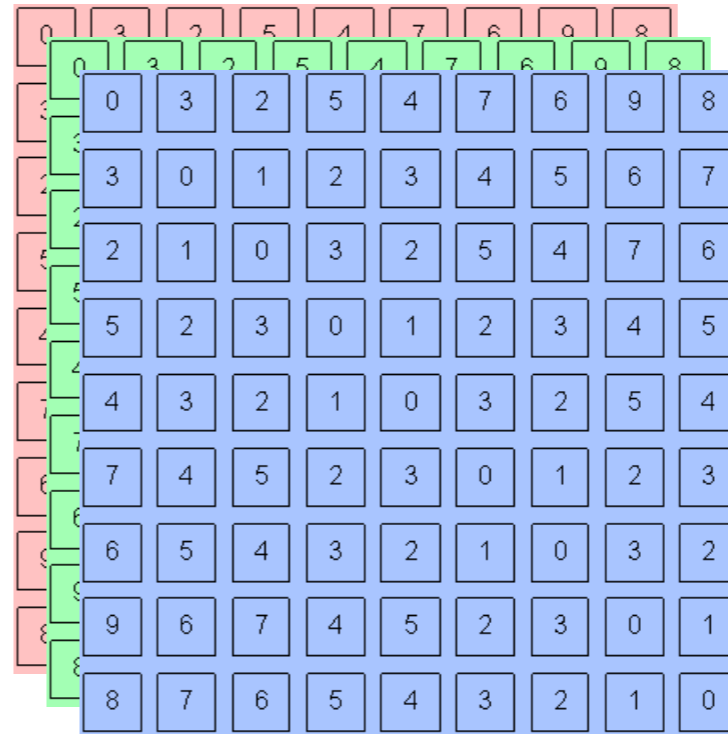

channel x height x width

Channels are usually RGB: Red, Green, and Blue

Other color spaces: HSV, HSL, LUV, XYZ, Lab, CMYK, etc

Convolution operator

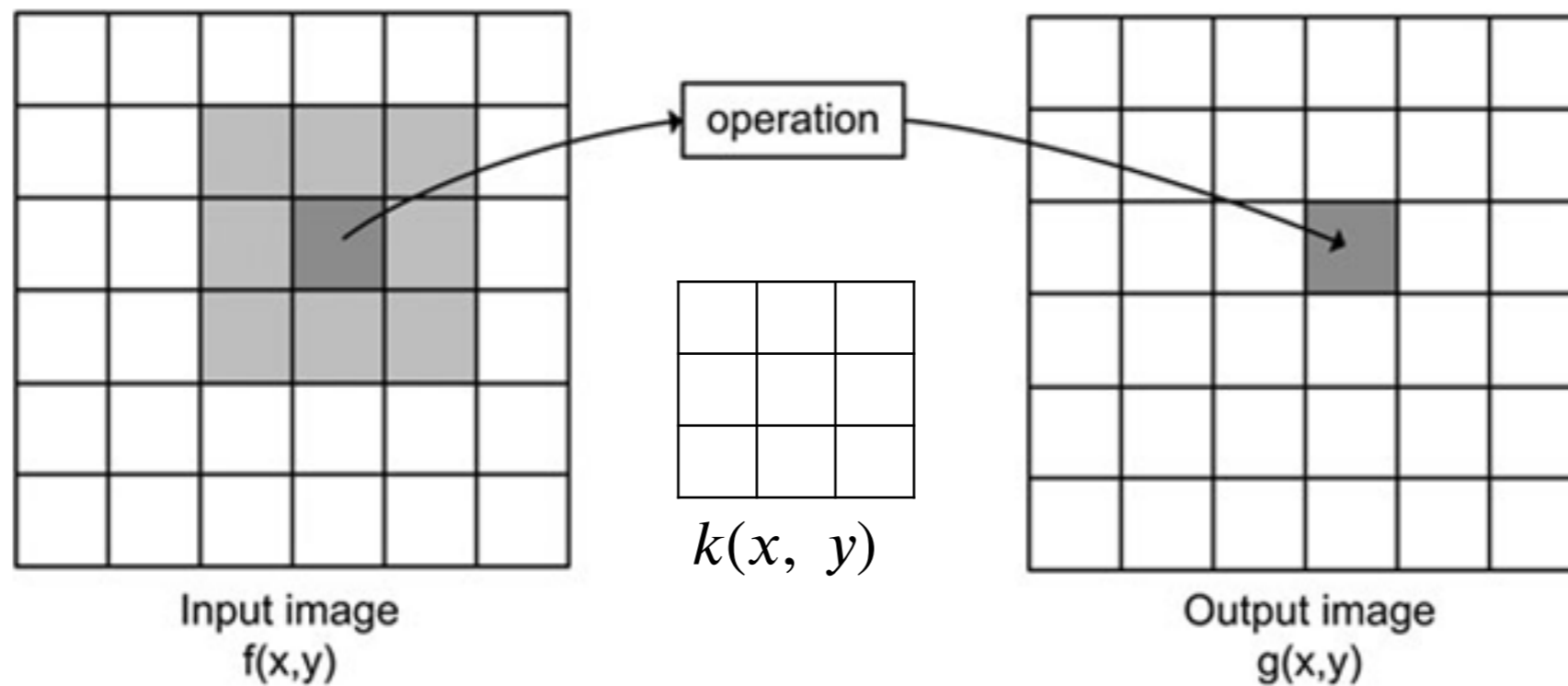

$$g(x, y) = \sum_v \sum_u k(u, v) f(x - u, y - v)$$

(filter, kernel)

Input image

*

Weights



Output image

4	5	7	6	6
3	2	8	0	7
6	7	7	1	5
3	0	1	1	1
4	3	2	1	7

*

0	0	0
1	0	1
0	0	0



	11	2	15	
	13	8	12	
	?			

demo:

<http://setosa.io/ev/image-kernels/>

Convolutional Layer (with 4 filters)

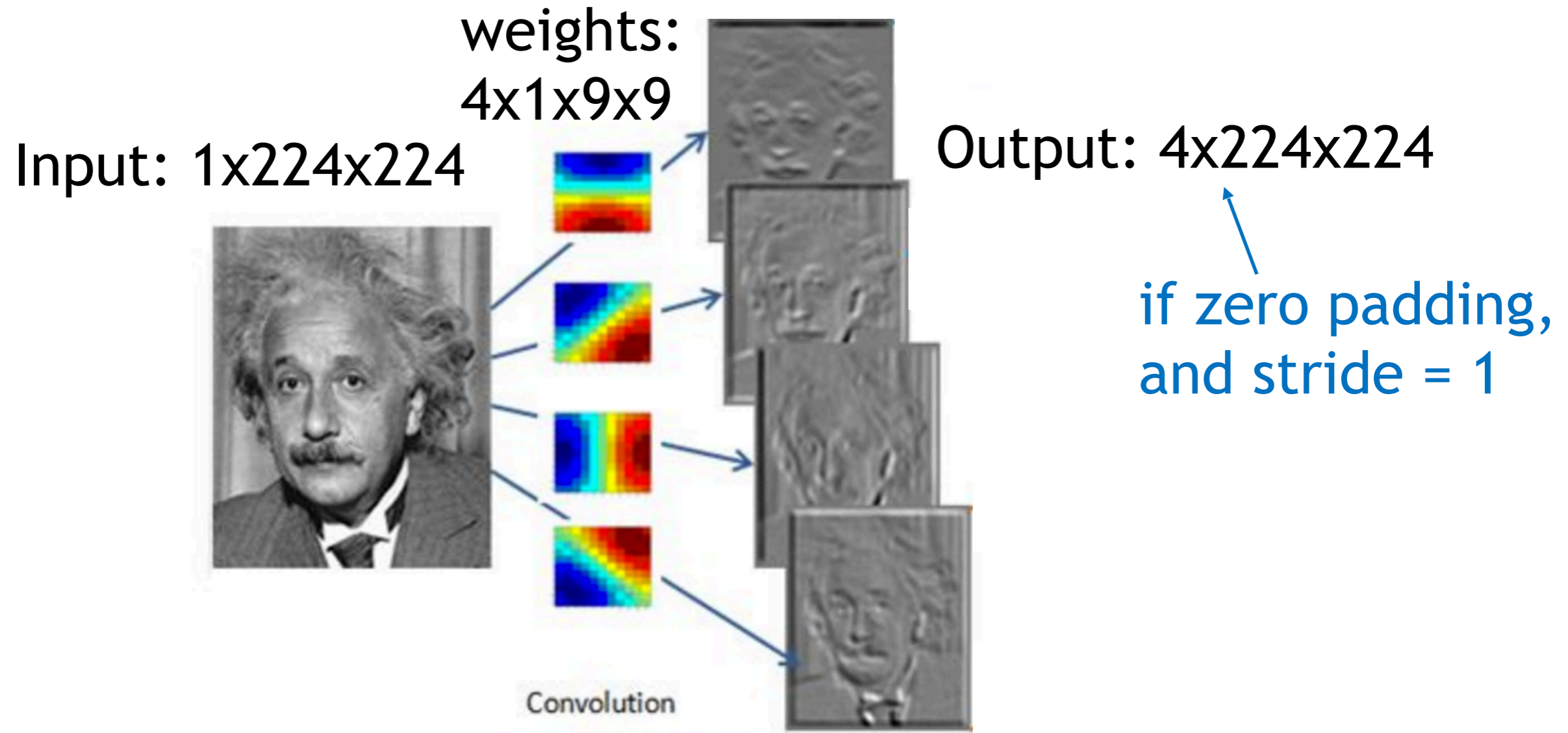

Convolutional Layer (with 4 filters)

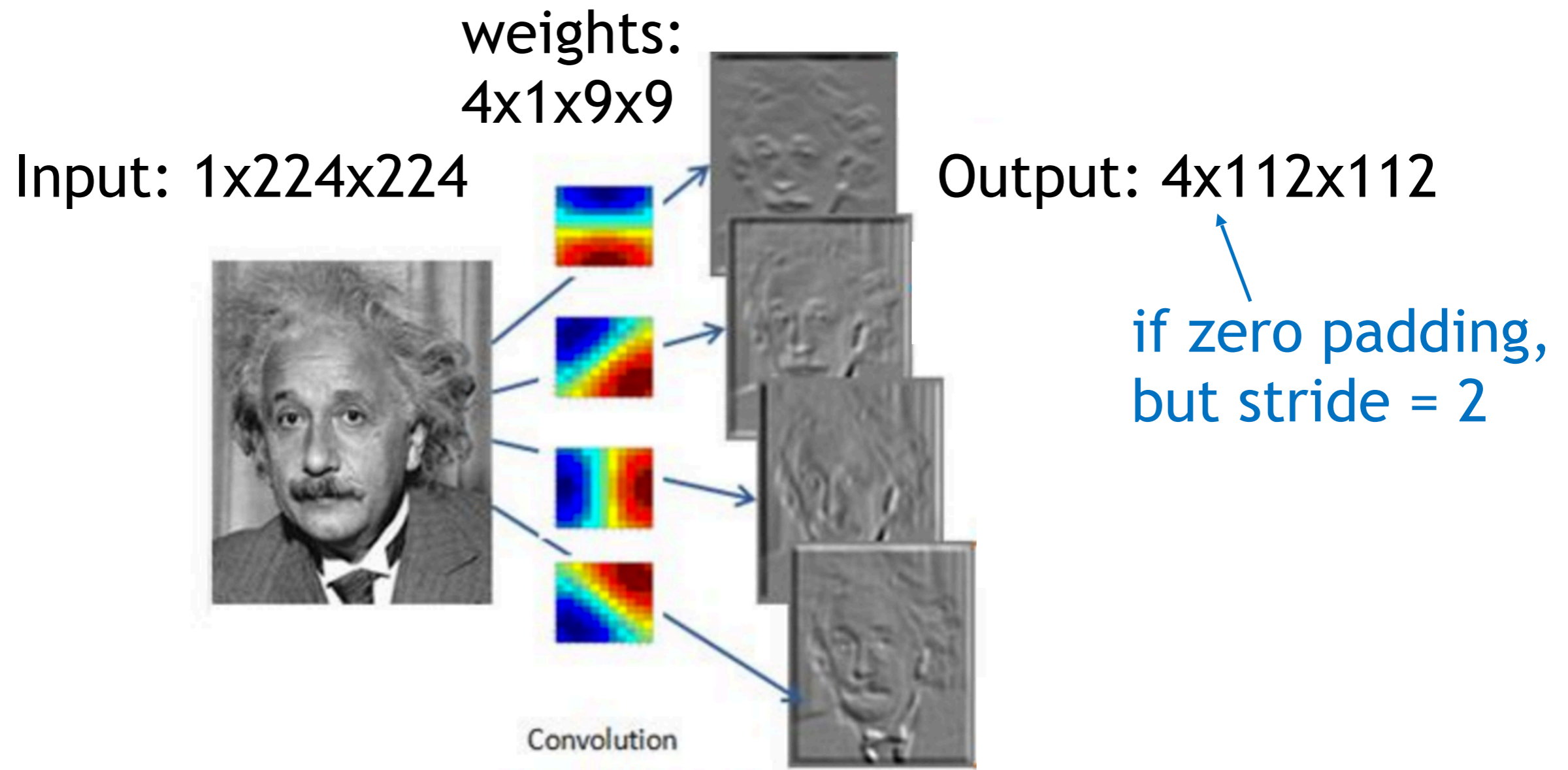

pooling layers also used to reduce dimensionality

Convolutional Layers:
slide a set of small filters over the image

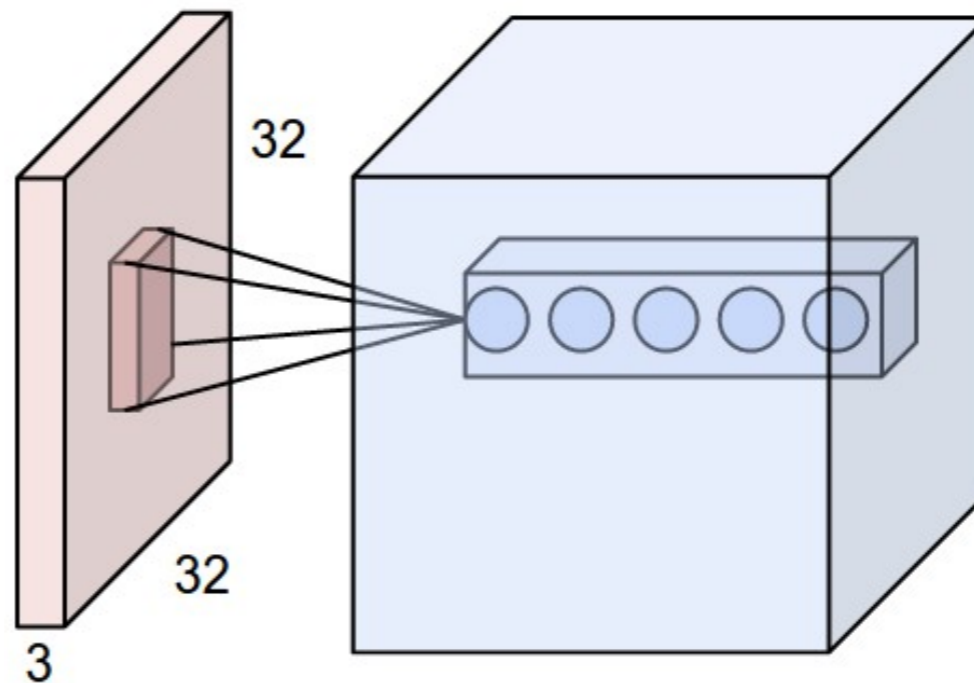

Pooling Layers:
reduce dimensionality of representation

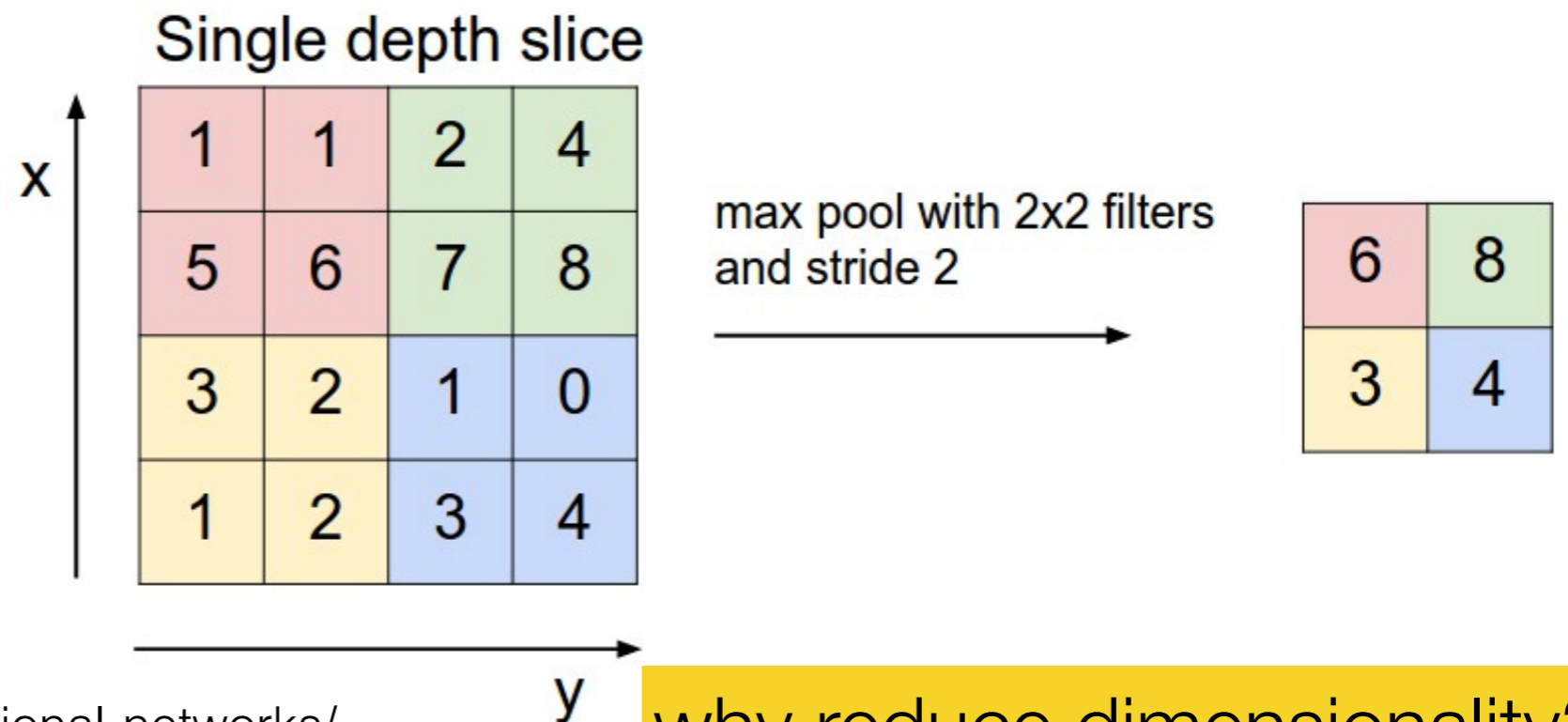

Alexnet

ImageNet Classification with Deep Convolutional Neural Networks

Alex Krizhevsky
University of Toronto
kriz@cs.utoronto.ca

Ilya Sutskever
University of Toronto
ilya@cs.utoronto.ca

Geoffrey E. Hinton
University of Toronto
hinton@cs.utoronto.ca

the paper that started the
deep learning revolution!

image classification

Classify an image into 1000 possible classes:

e.g. Abyssinian cat, Bulldog, French Terrier, Cormorant,
Chickadee,
red fox, banjo, barbell, hourglass, knot, maze, viaduct, etc.



cat, tabby cat (0.71)
Egyptian cat (0.22)
red fox (0.11)
.....

train on the ImageNet
challenge dataset,
~1.2 million images

Alexnet

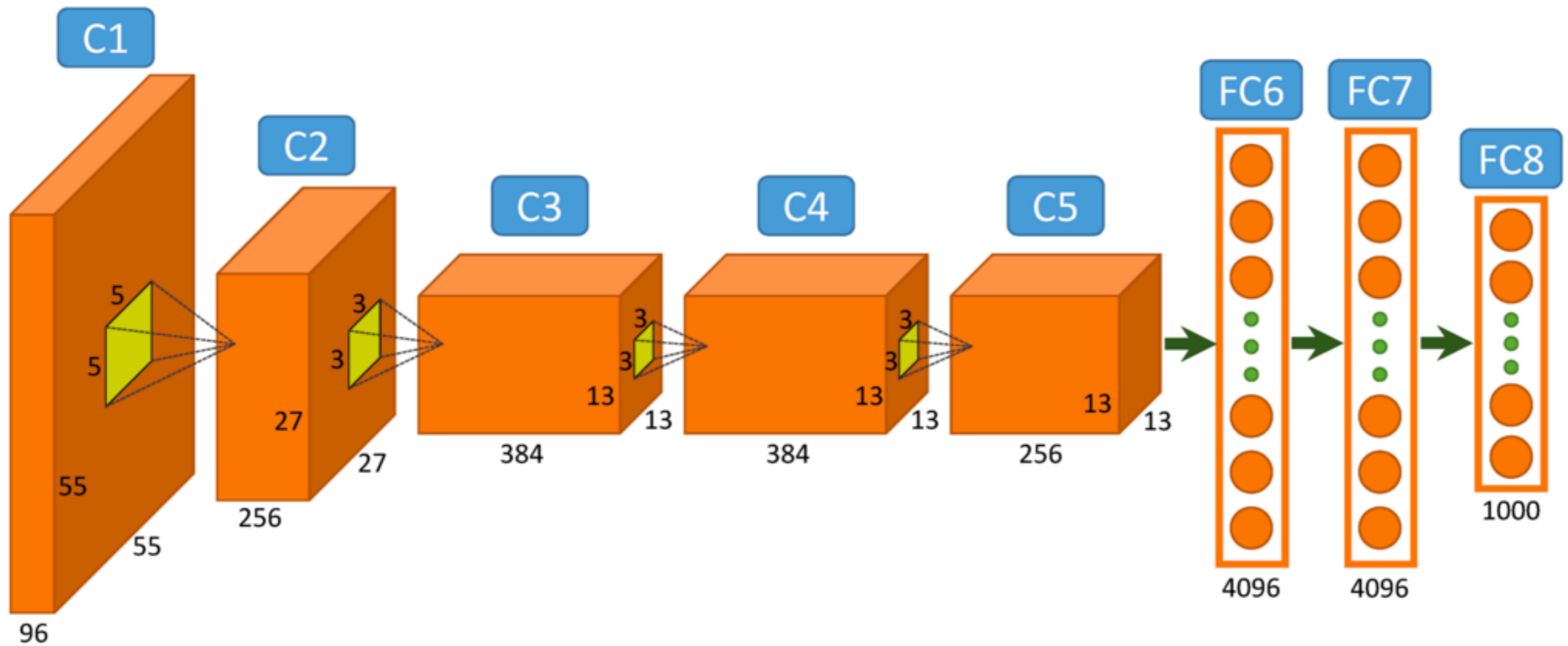

<https://www.saagie.com/fr/blog/object-detection-part1>

Alexnet

conv+pool

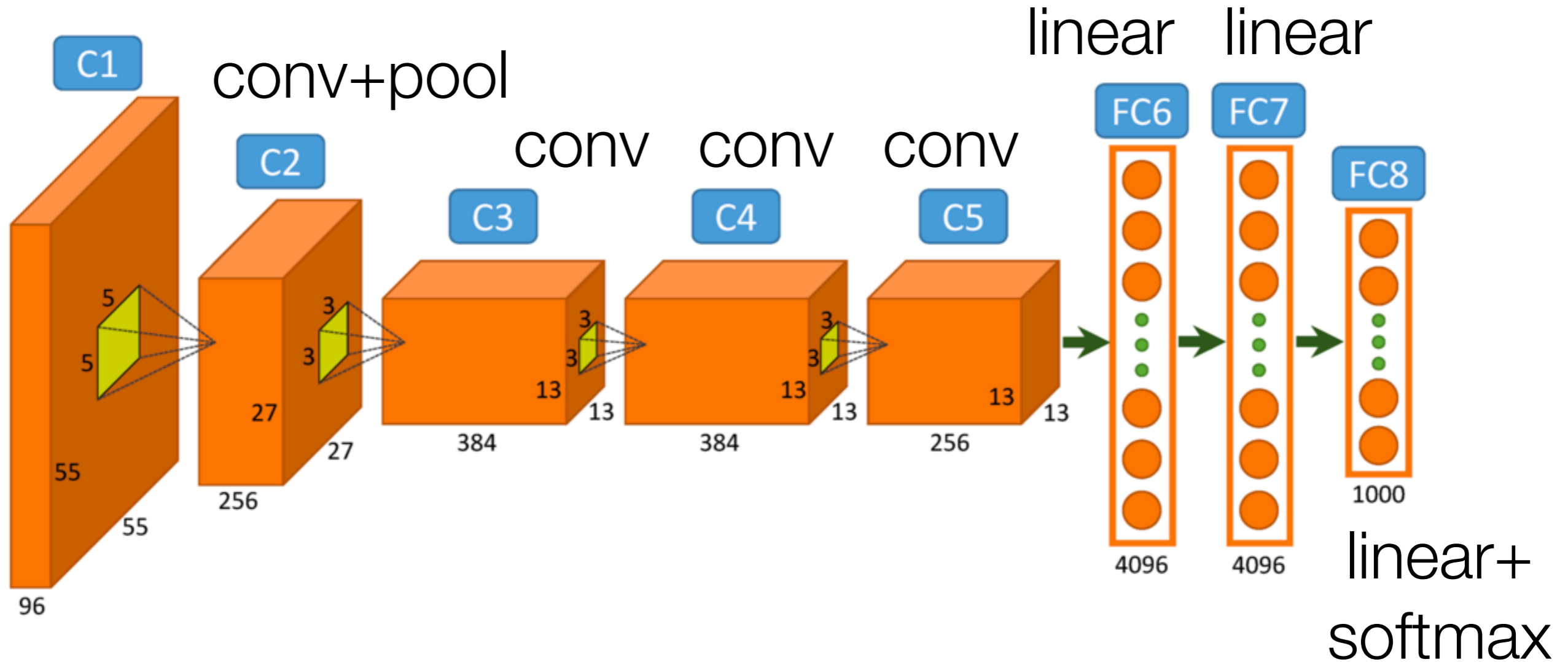

What is happening?

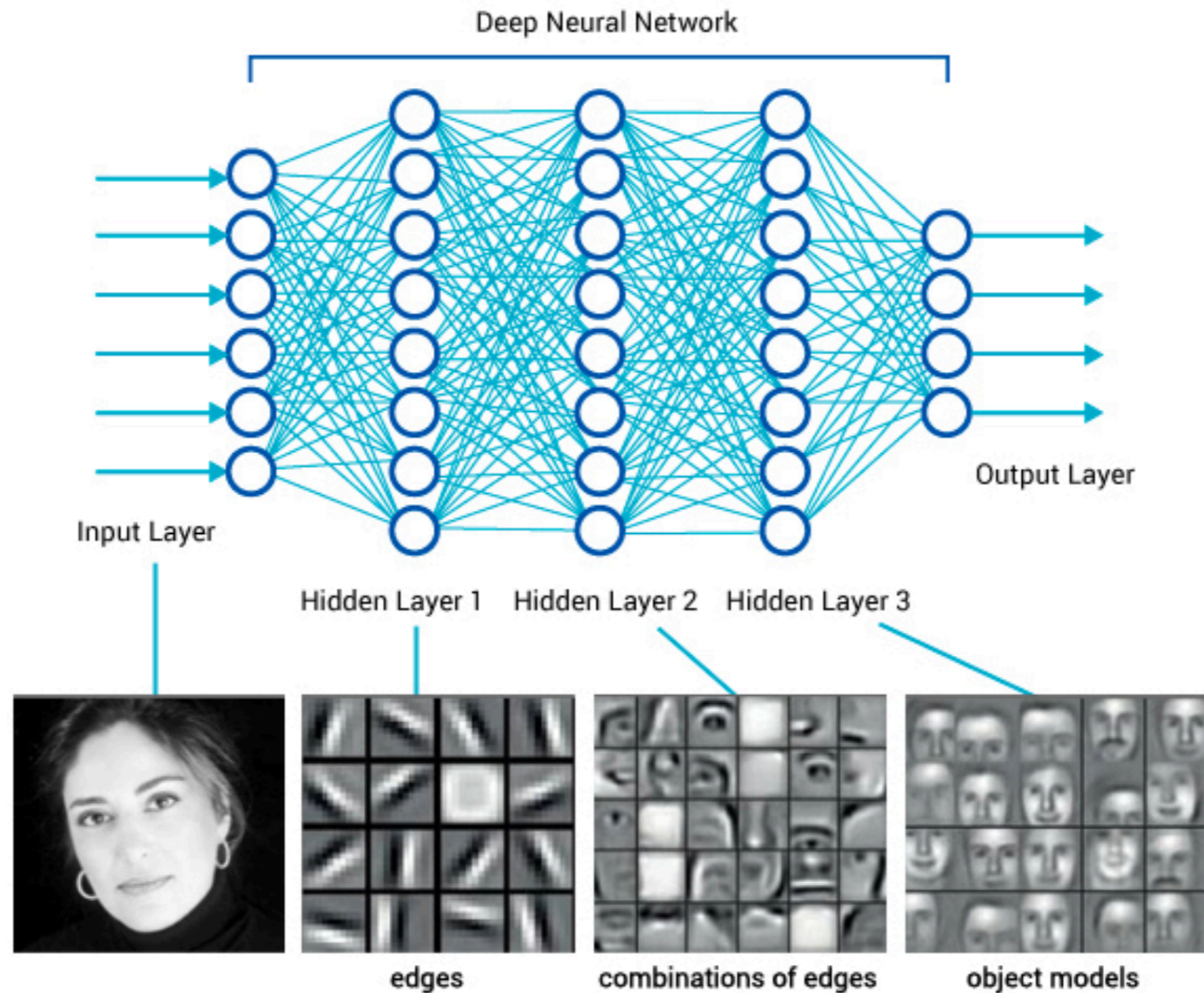

Revolution of Depth

AlexNet, 8 layers
(ILSVRC 2012)



VGG, 19 layers
(ILSVRC 2014)



ResNet, **152 layers**
(ILSVRC 2015)

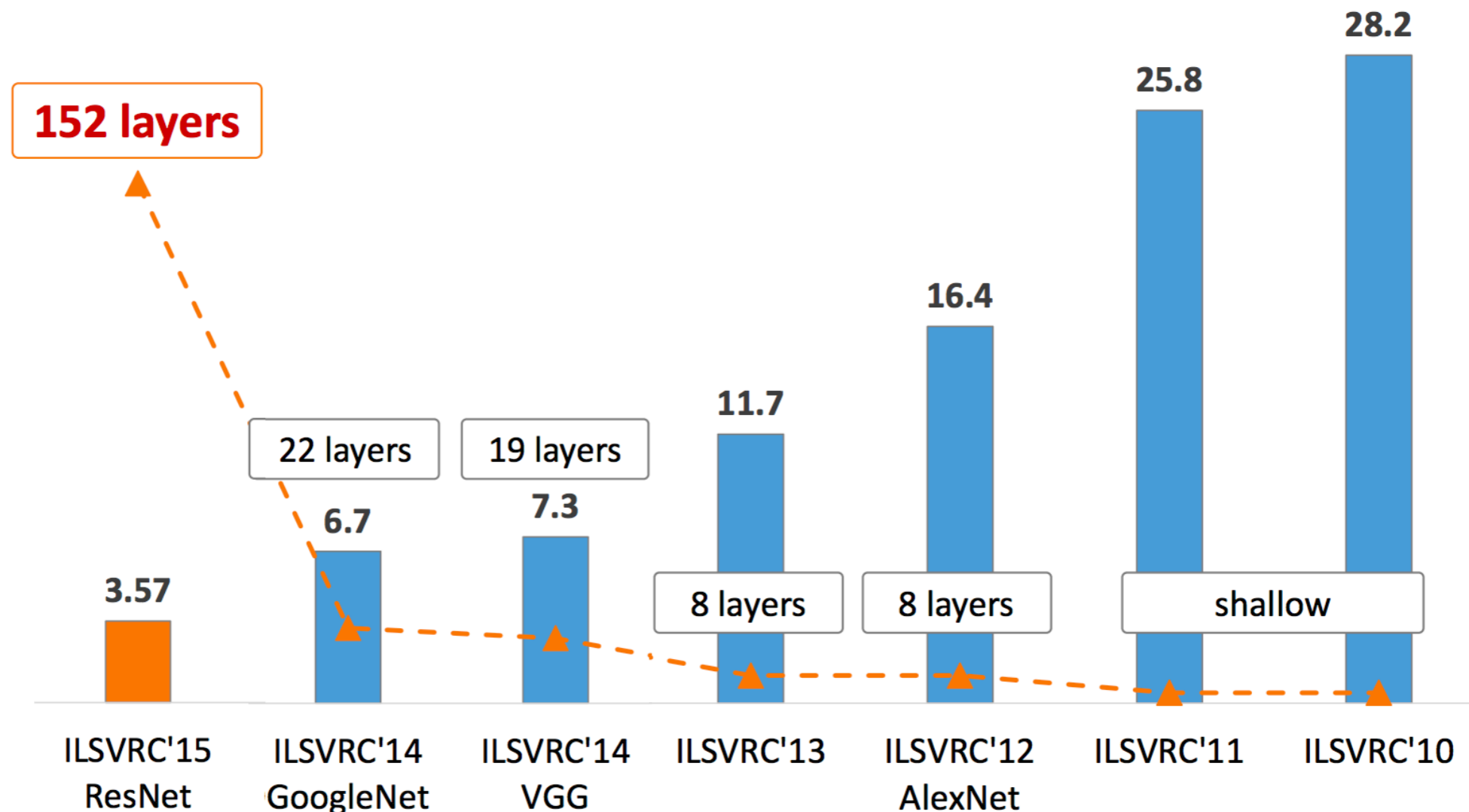

ImageNet pretraining -> Instagram pretraining

Bigger models are saturated on ImageNet, but with more data bigger models do better

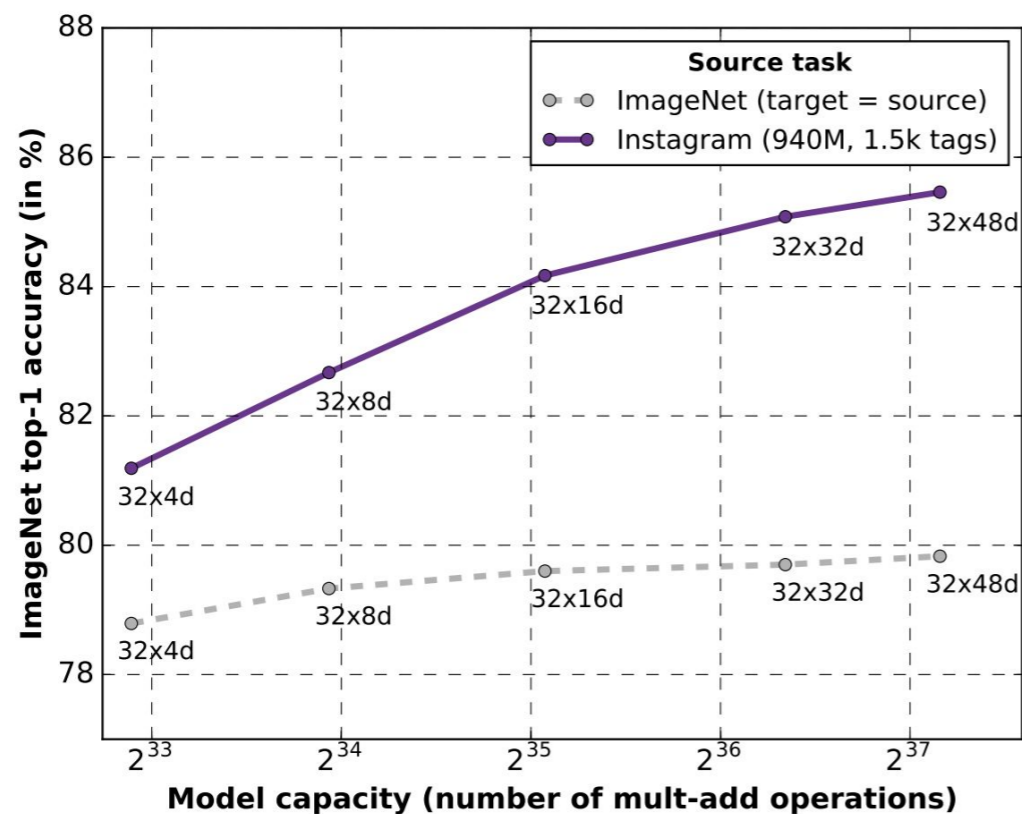

Biggest network was pretrained on 3.5B Instagram images

Trained on 336 GPUs for 22 days

at the end of the day, we generate a fixed size vector from an image and run a classifier over it

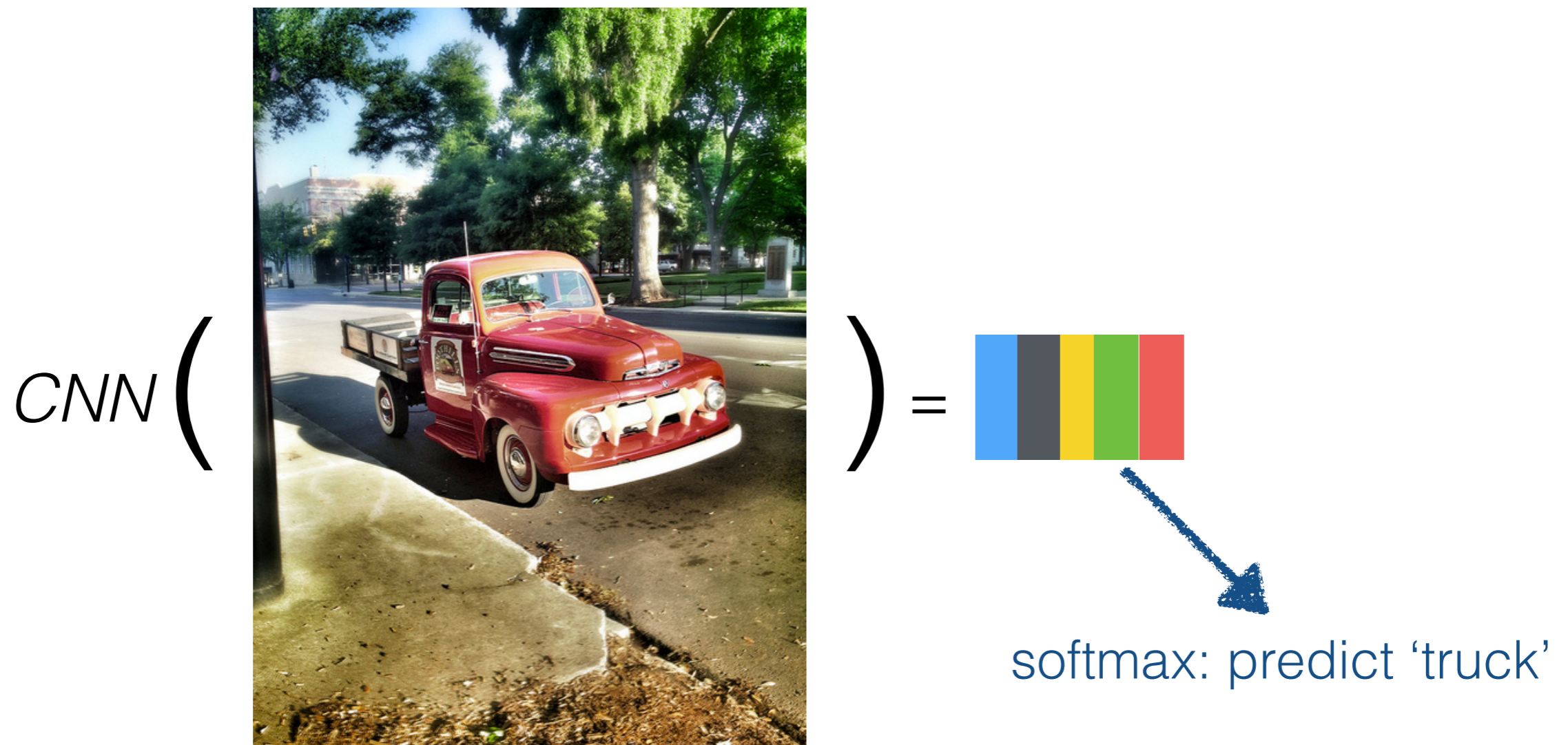

key insight: this vector is useful for many more tasks than just image classification!
we can use it for *transfer learning*

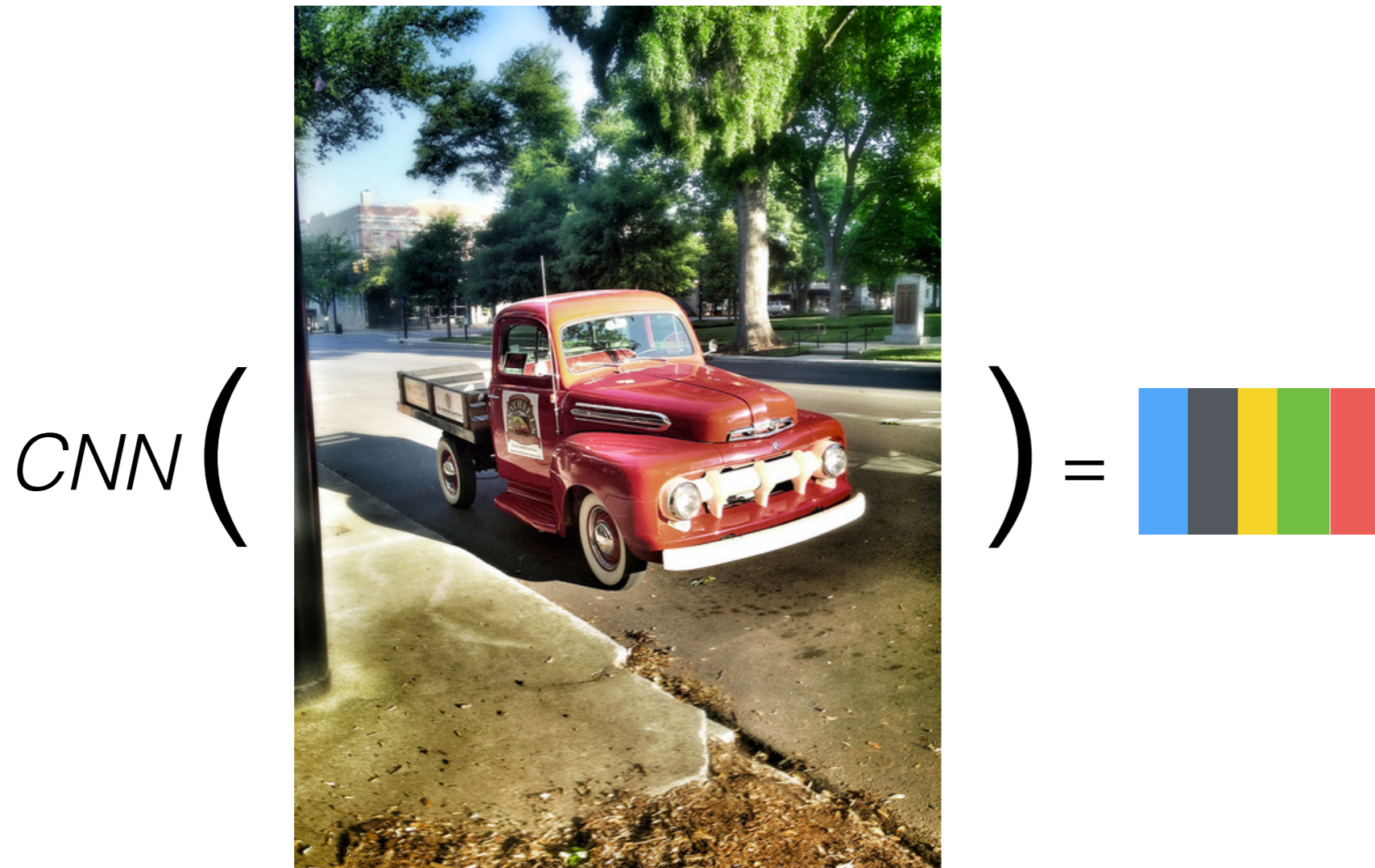

simple visual QA

- $i = \text{CNN}(\text{image})$ > use an existing network trained for image classification and freeze weights
- $q = \text{RNN}(\text{question})$ > learn weights
- $\text{answer} = \text{softmax}(\text{linear}([i; q]))$

why isn't this a good way of doing visual QA?



How many benches are shown?

visual attention

- Use the question representation q to determine where in the image to look



How many benches are shown?



softmax:
predict answer

attention over final convolutional
layer in network: 196 boxes, captures
color and positional information

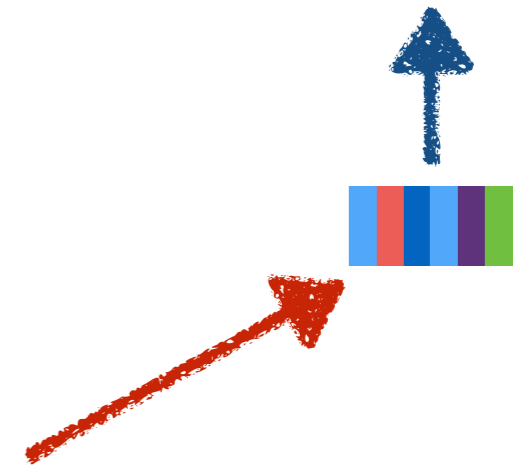
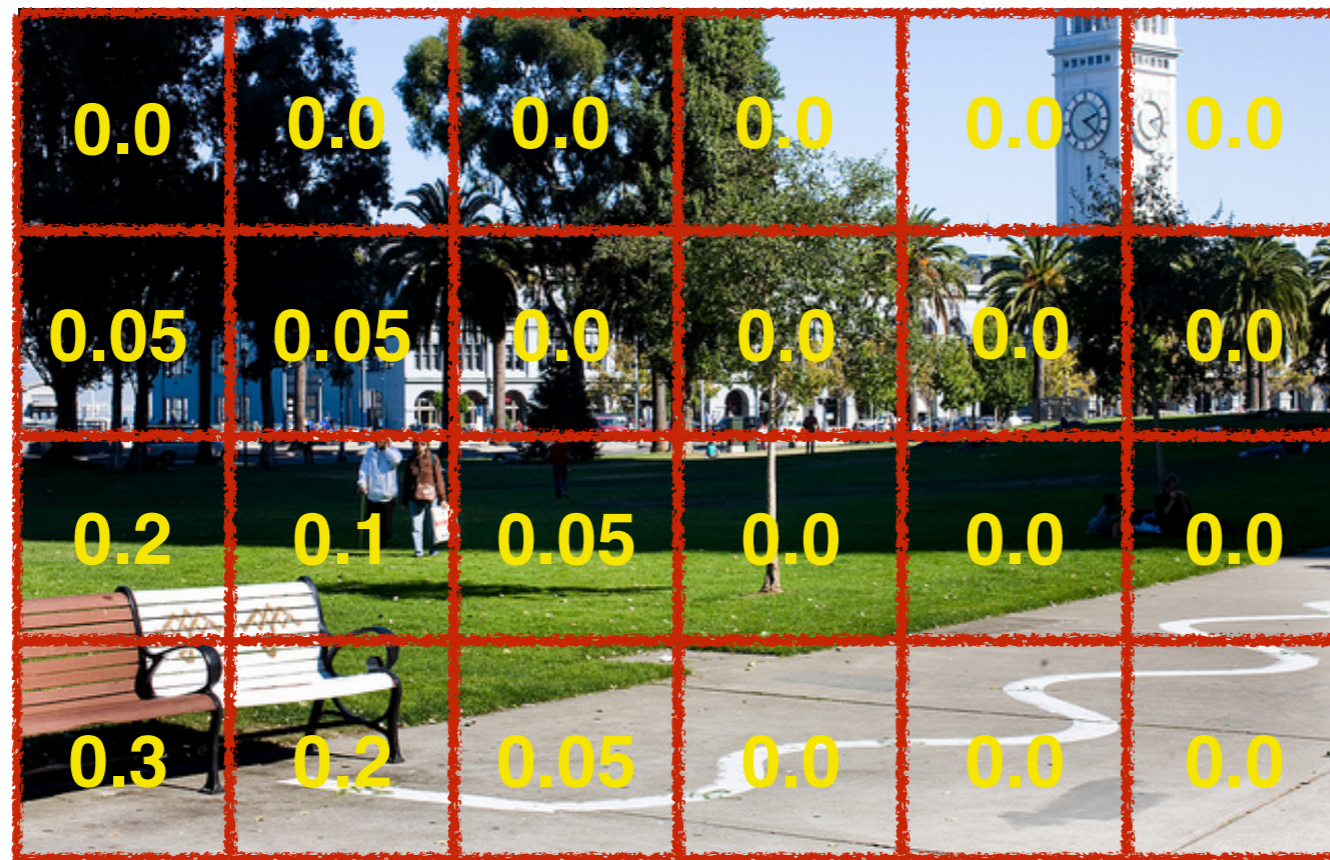

How many benches are shown?

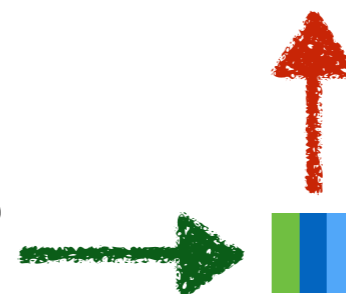

softmax:
predict answer

attention over final convolutional
layer in network: 196 boxes, captures
color and positional information

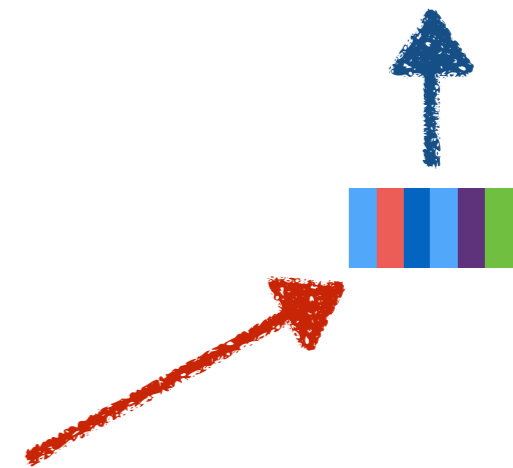
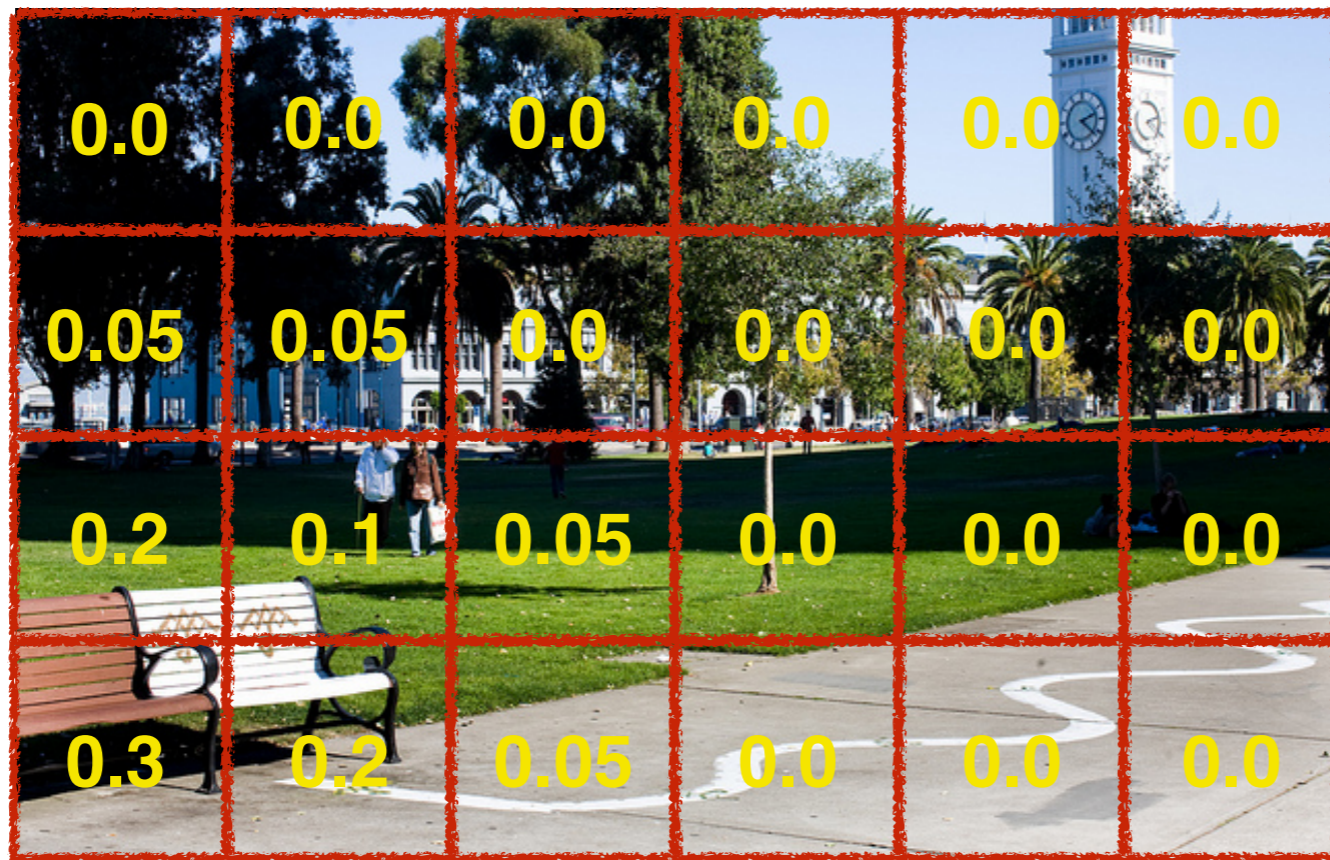

how can we
compute these
attention
scores?

How many benches are shown?

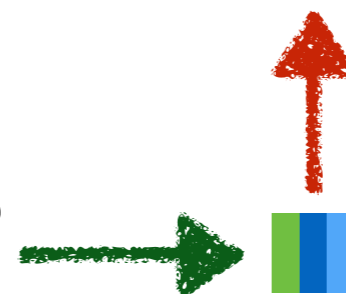

hard attention

attention over final convolutional layer in network: 196 boxes, captures color and positional information

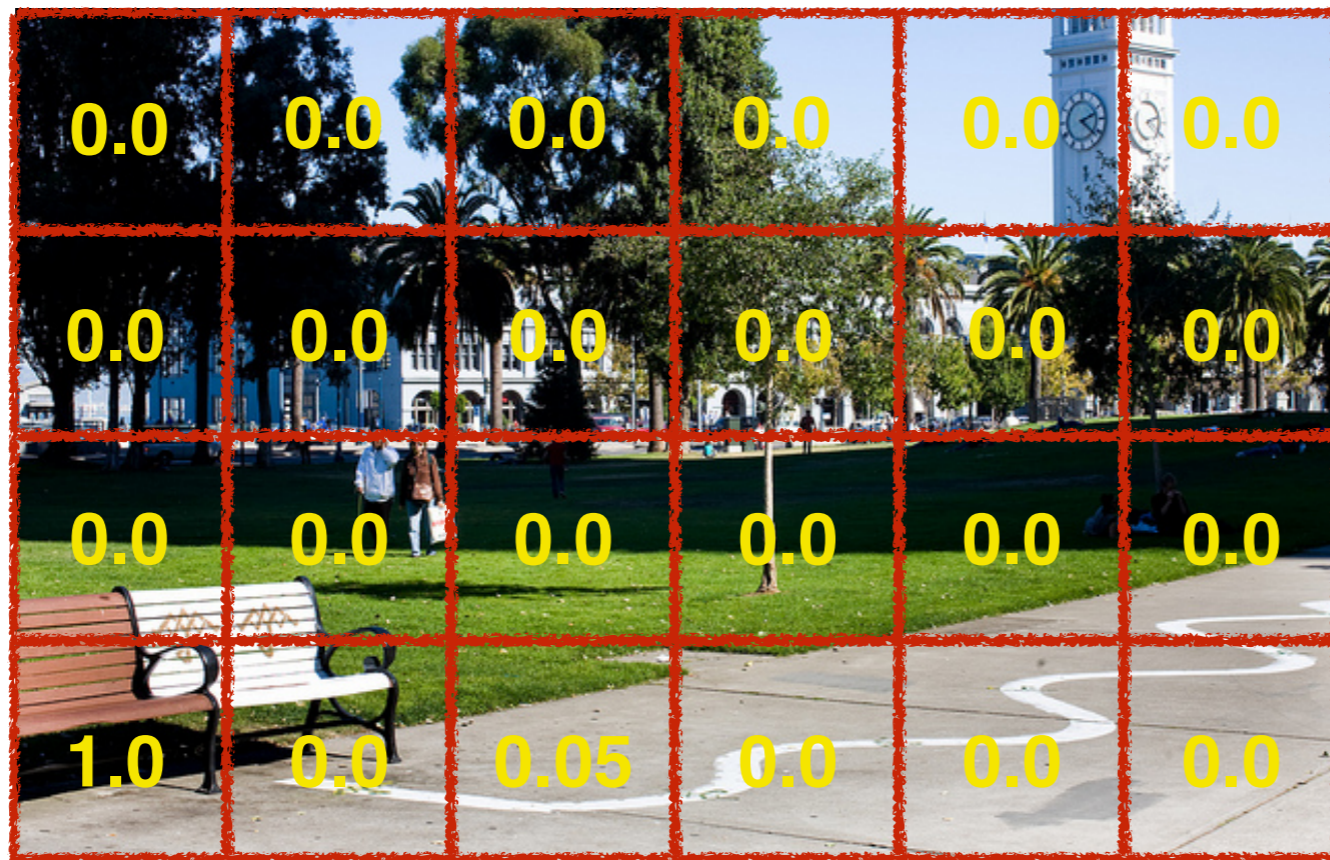

softmax:
predict answer

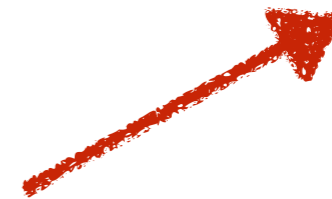
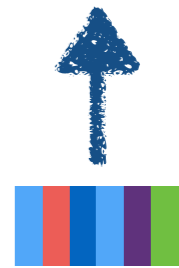

we can use *reinforcement learning* to focus on just one box

How many benches are shown?

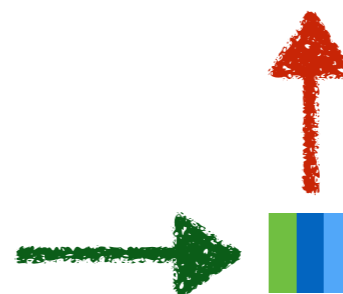

Grounded question answering

*Is there a red
shape above
a circle?*

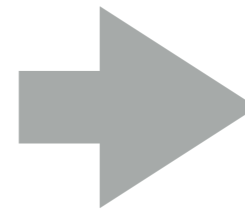
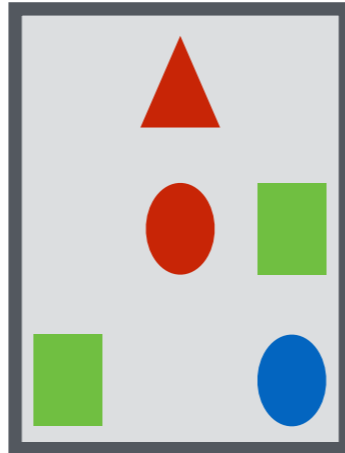

yes

Neural nets learn lexical groundings

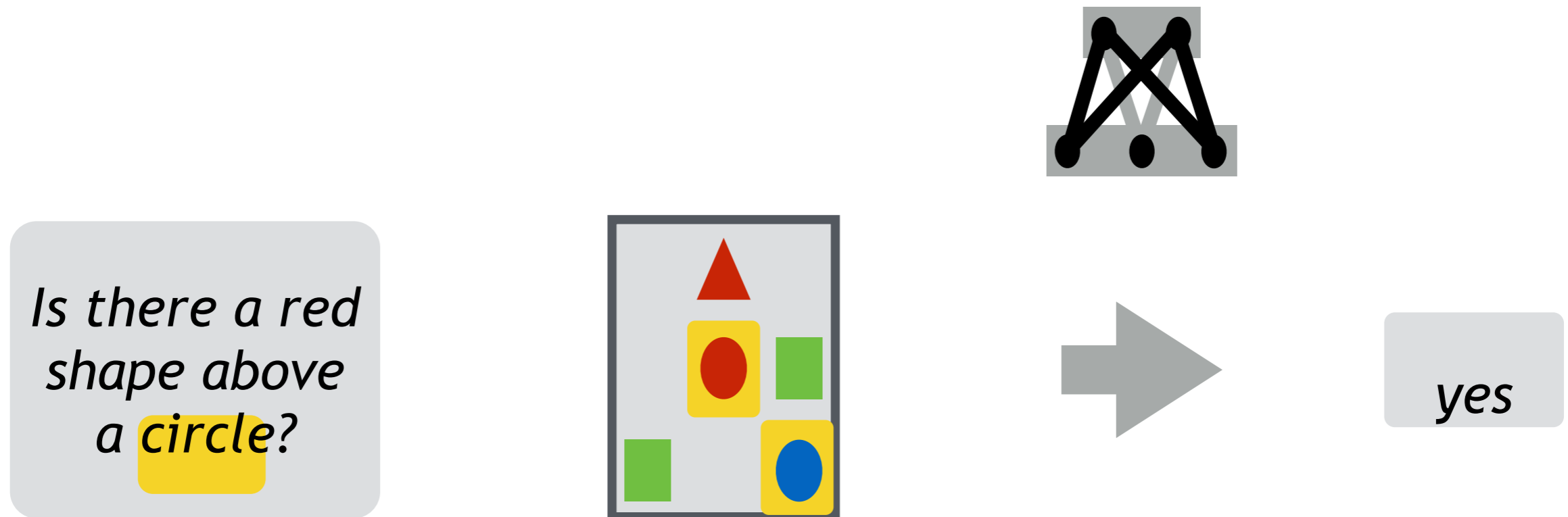

[Iyyer et al. 2014, Bordes et al. 2014,
Yang et al. 2015, Malinowski et al., 2015]

Semantic parsers learn composition

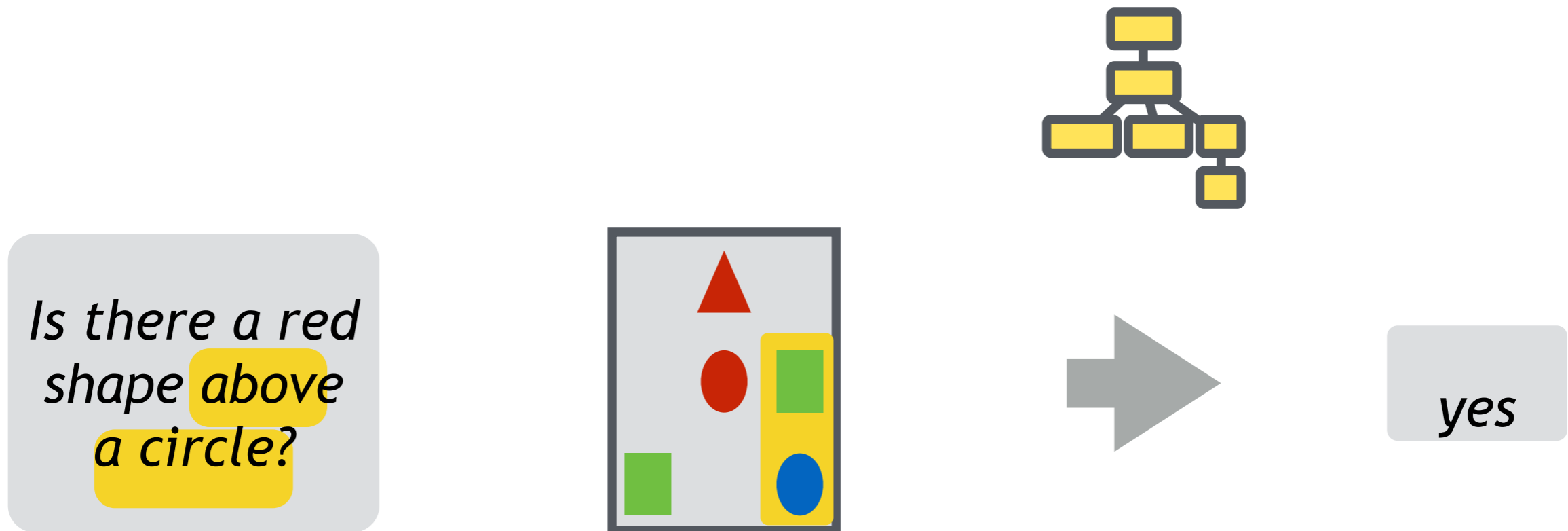

[Wong & Mooney 2007, Kwiatkowski et al. 2010, Liang et al. 2011, A et al. 2013]

Neural module networks learn both!

*Is there a red
shape above
a circle?*

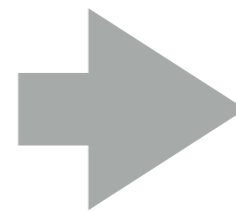
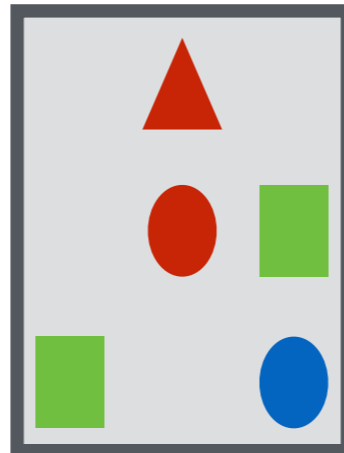

yes

Neural module networks

*Is there a red shape
above a circle?*

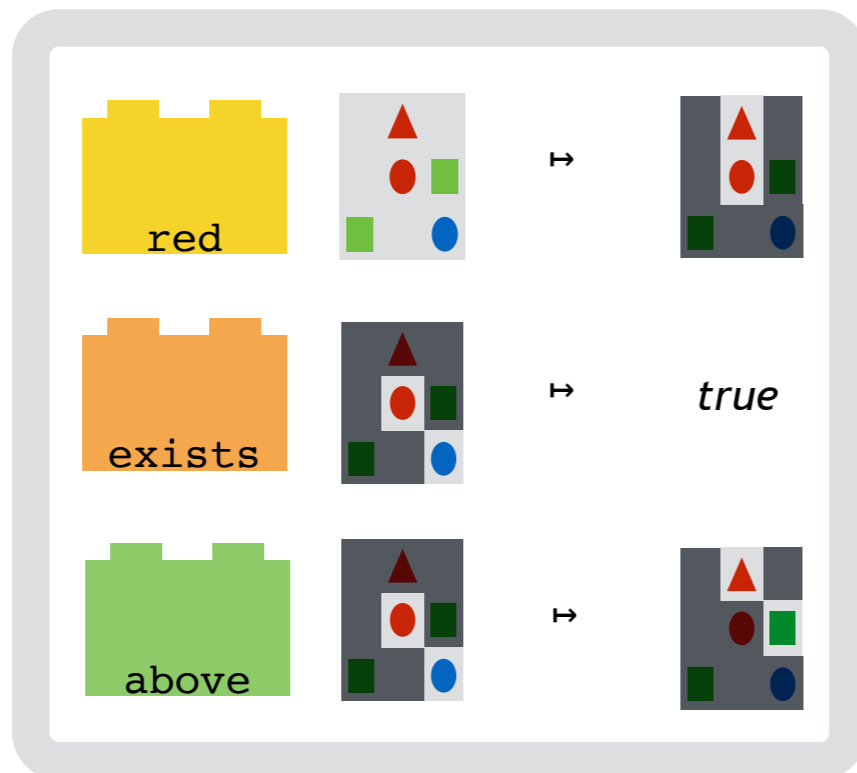

Neural module networks

*Is there a red shape
above a circle?*

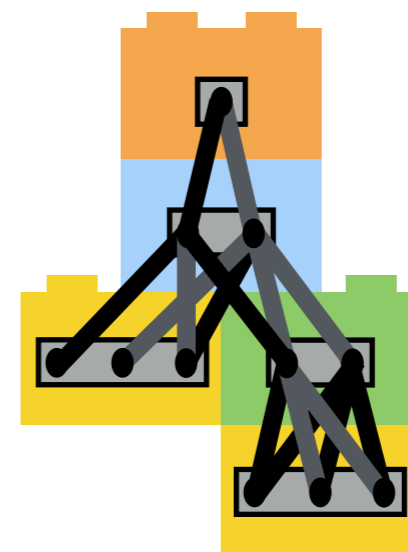
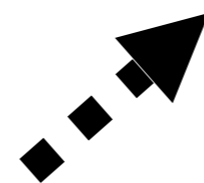
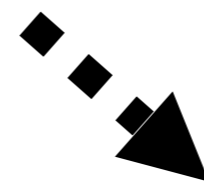
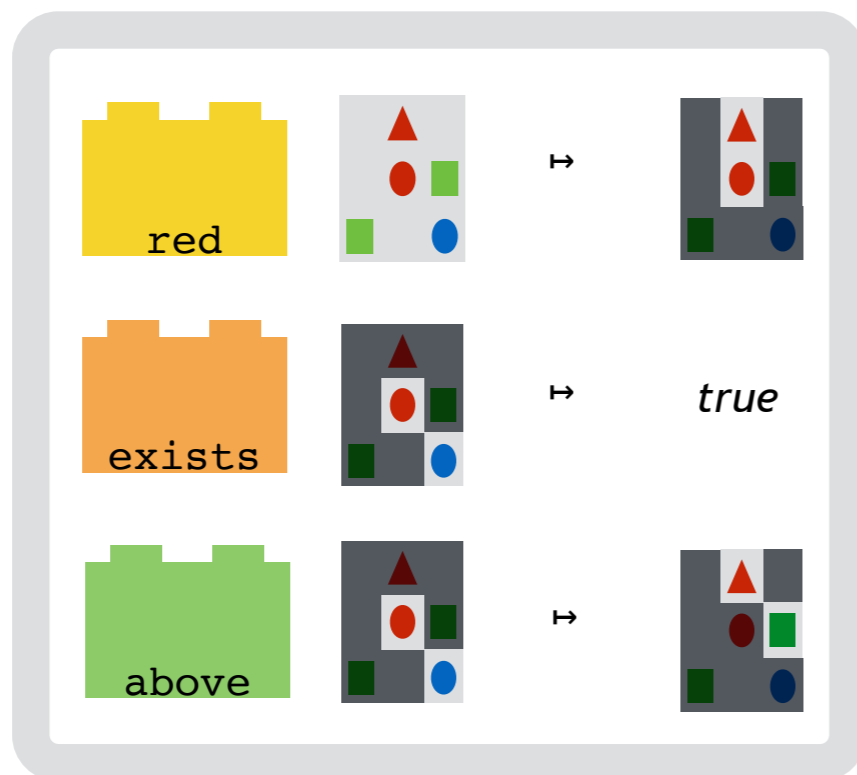

Neural module networks

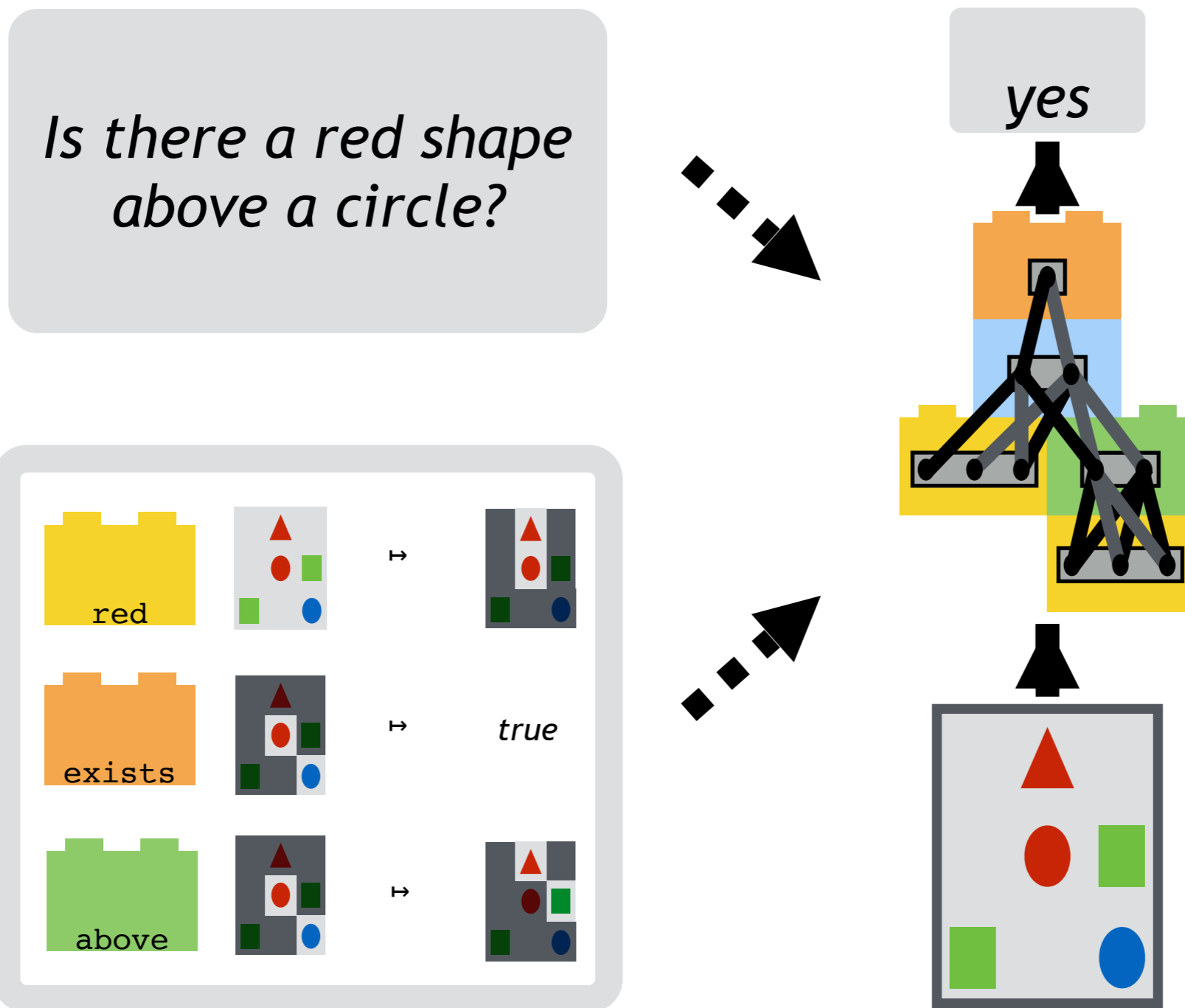

Sentence meanings are computations

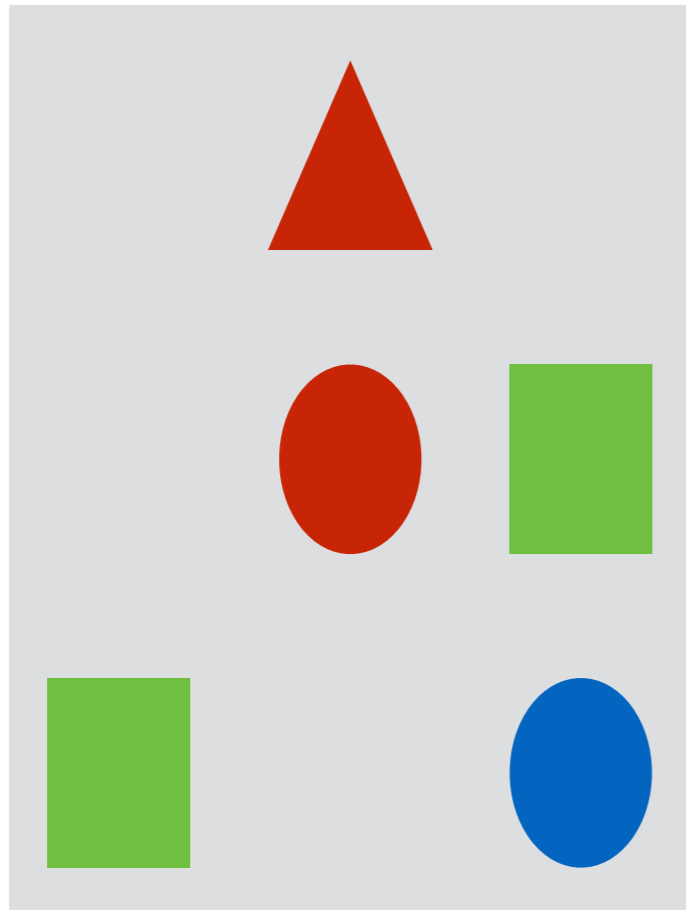

Is there a red shape above a circle?

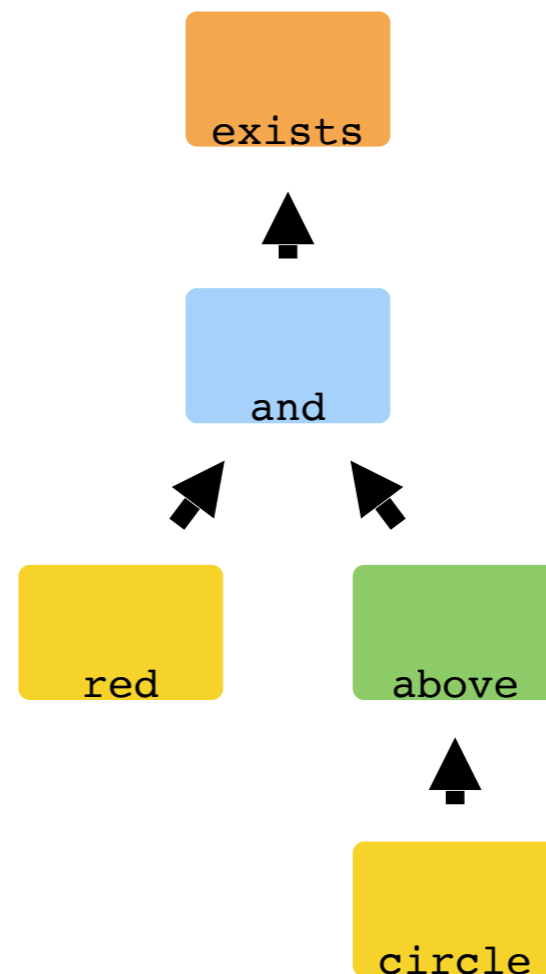

NLVR²: natural language for visual reasoning! (Suhr et al., 2018)



TRUE OR FALSE: the left image contains twice the number of dogs as the right image, and at least two dogs in total are standing.

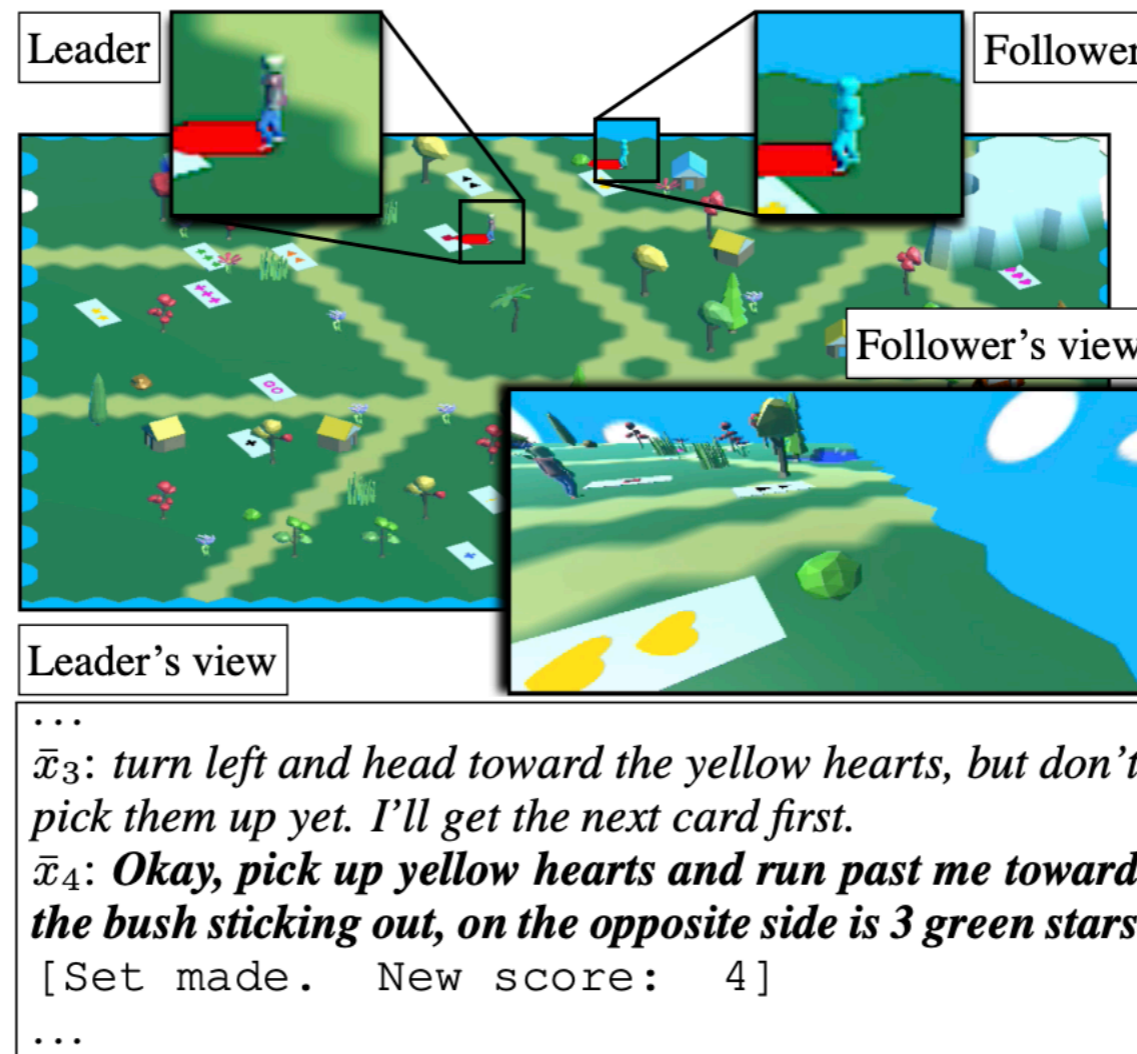

Figure 1: A snapshot from an interaction in CEREALBAR. The current instruction is in bold. The large image shows the entire environment. This overhead view is available only to the leader. The follower sees a first-person view only (bottom right). The zoom boxes (top) show the leader and follower.

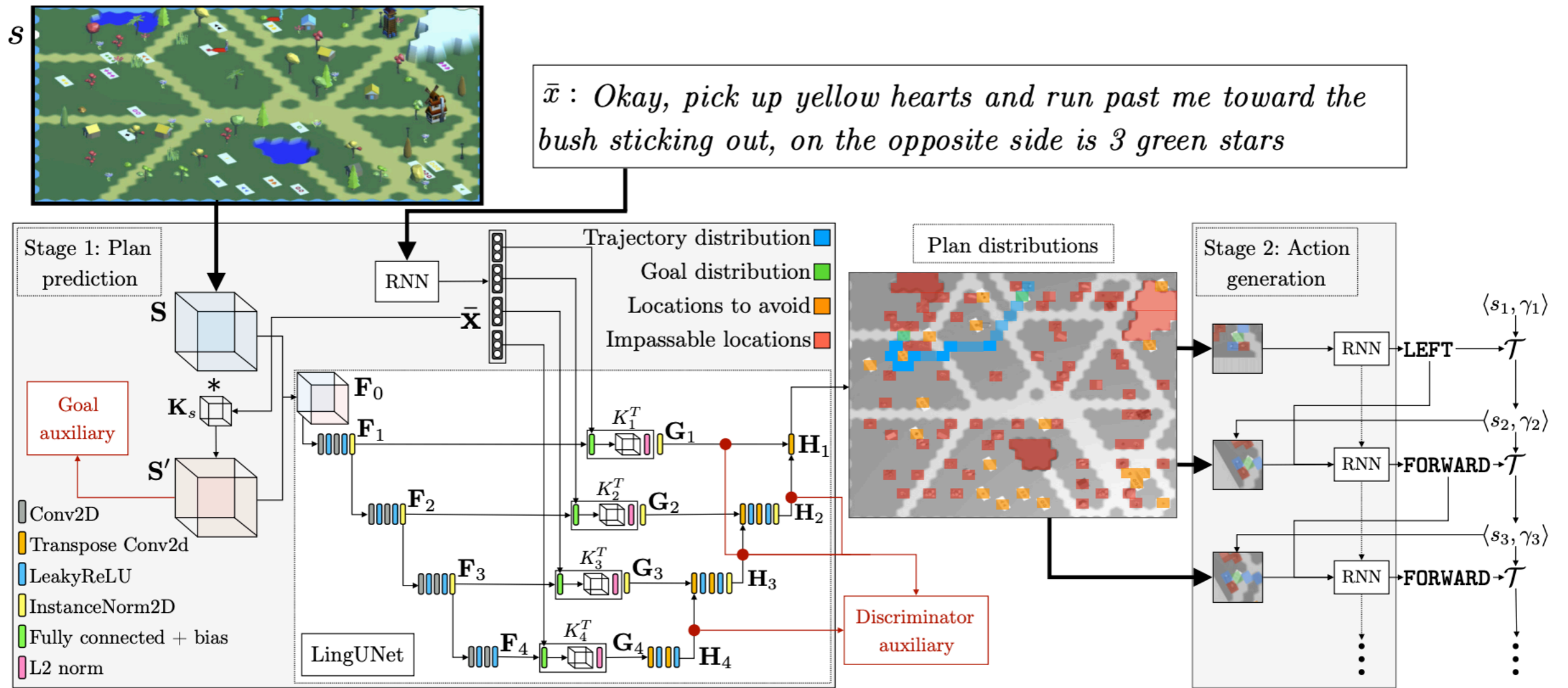

Image Captioning

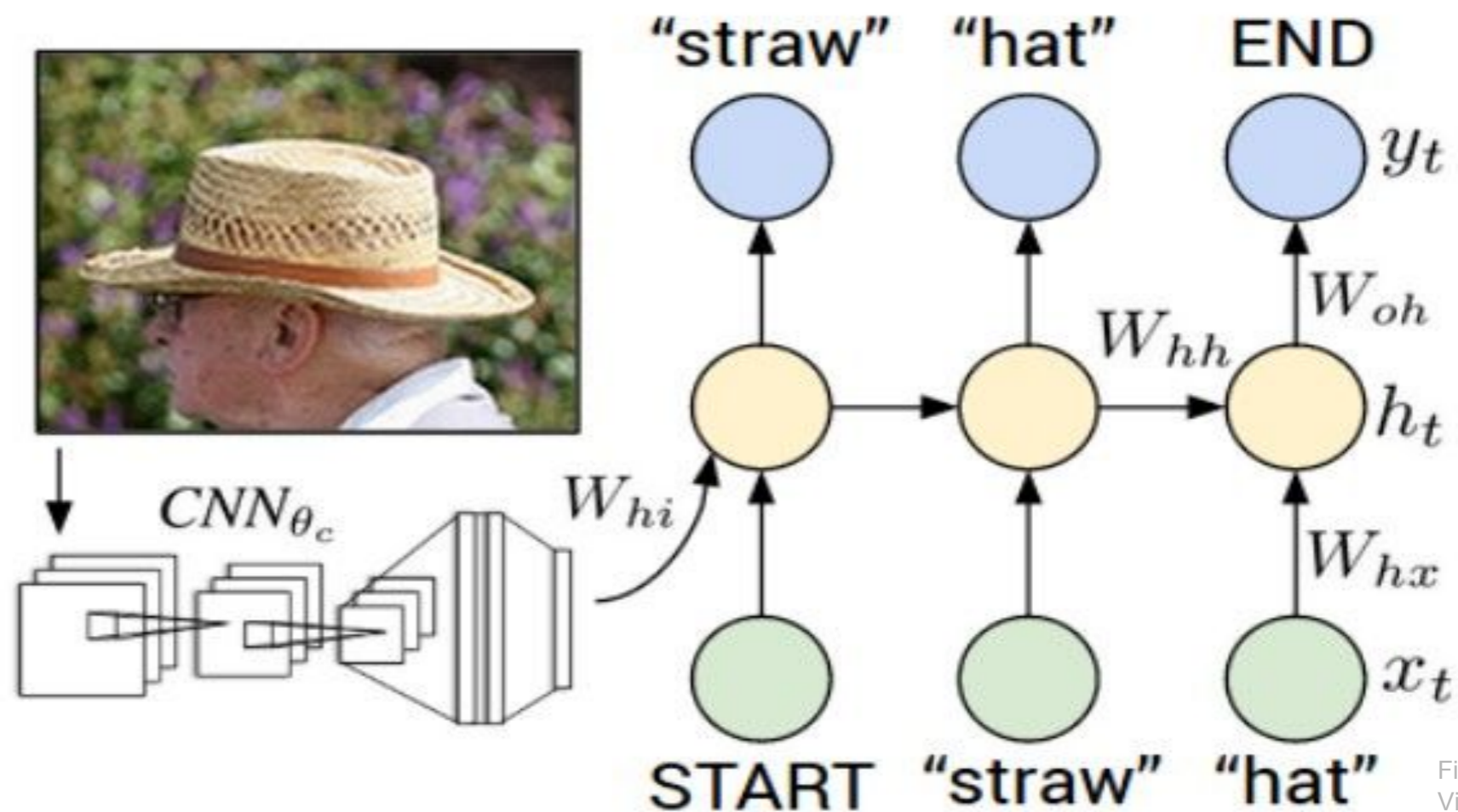

Figure from
Visual-Semantic
Image Description
copyright
Reproduced

Explain Images with Multimodal Recurrent Neural Networks, Mao et al.

Deep Visual-Semantic Alignments for Generating Image Descriptions, Karpathy and Fei-Fei

Show and Tell: A Neural Image Caption Generator, Vinyals et al.

Long-term Recurrent Convolutional Networks for Visual Recognition and Description, Donahue et al.

Learning a Recurrent Visual Representation for Image Caption Generation, Chen and Zitnick

test image



This image is CC0 public domain



test image

this is our ImageNet CNN, now used as a feature extractor

image

conv-64

conv-64

maxpool

conv-128

conv-128

maxpool

conv-256

conv-256

maxpool

conv-512

conv-512

maxpool

conv-512

conv-512

maxpool

FC-4096

FC-4096

FC-1000

softmax



test image

this is our
ImageNet
CNN, now
used as a
feature
extractor

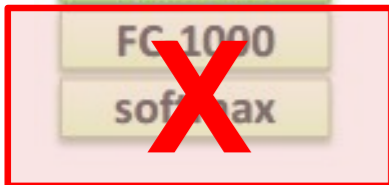



test image

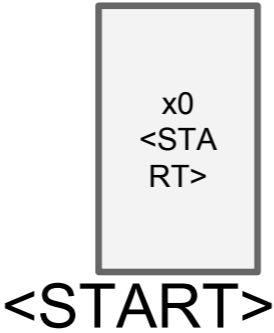



test image



v

Wih

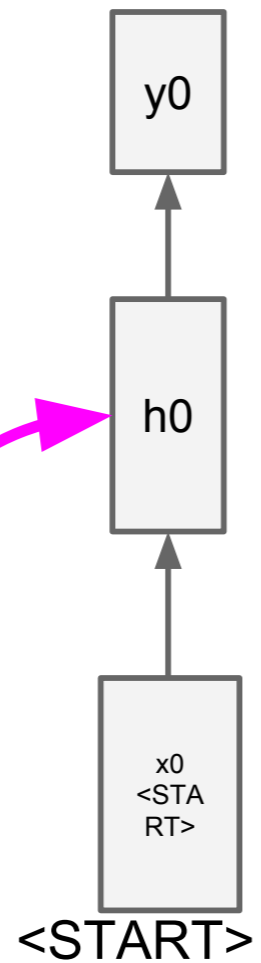

before:

$$h = \tanh(W_{xh} * x + W_{hh} * h)$$

now:

$$h = \tanh(W_{xh} * x + W_{hh} * h + W_{ih} * v)$$

let's use the image features to create a conditional LM



test image

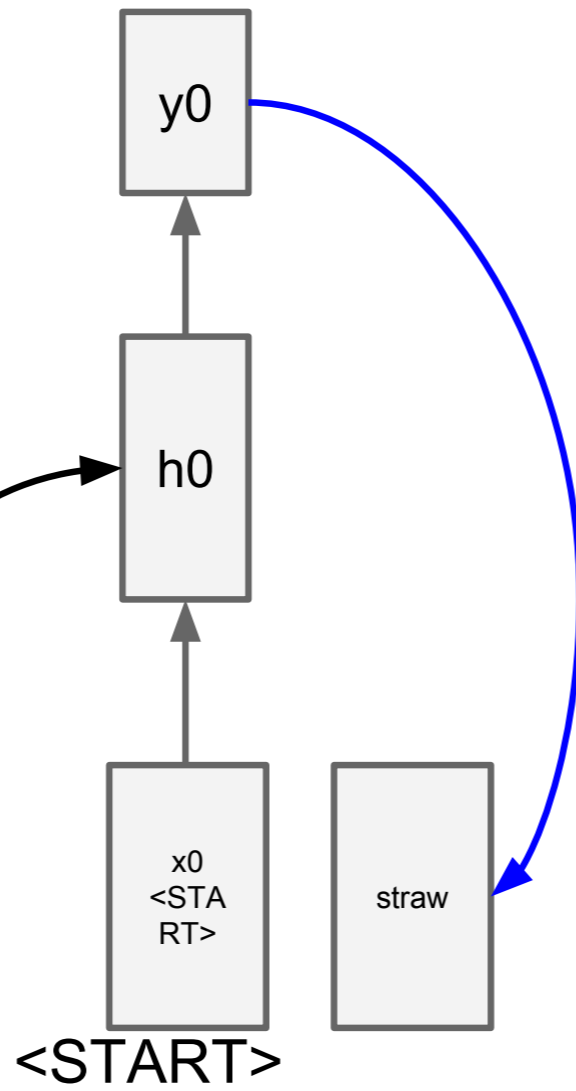

sample!

test image

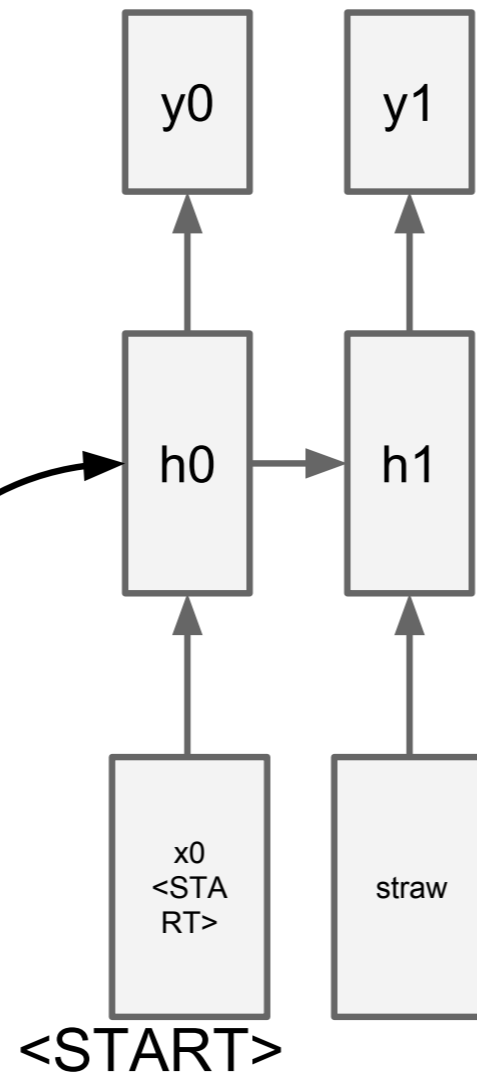

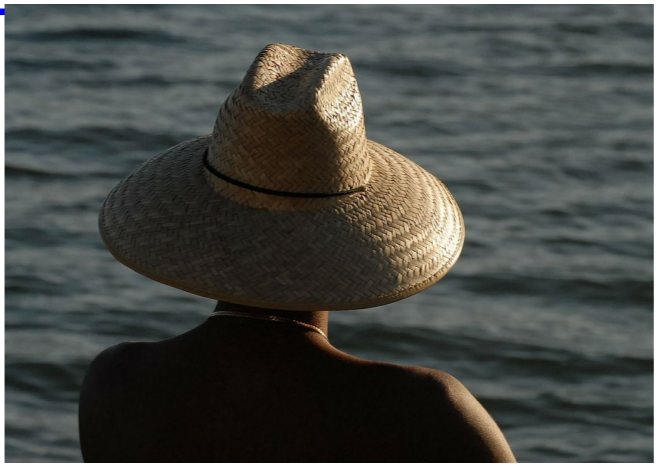

test image

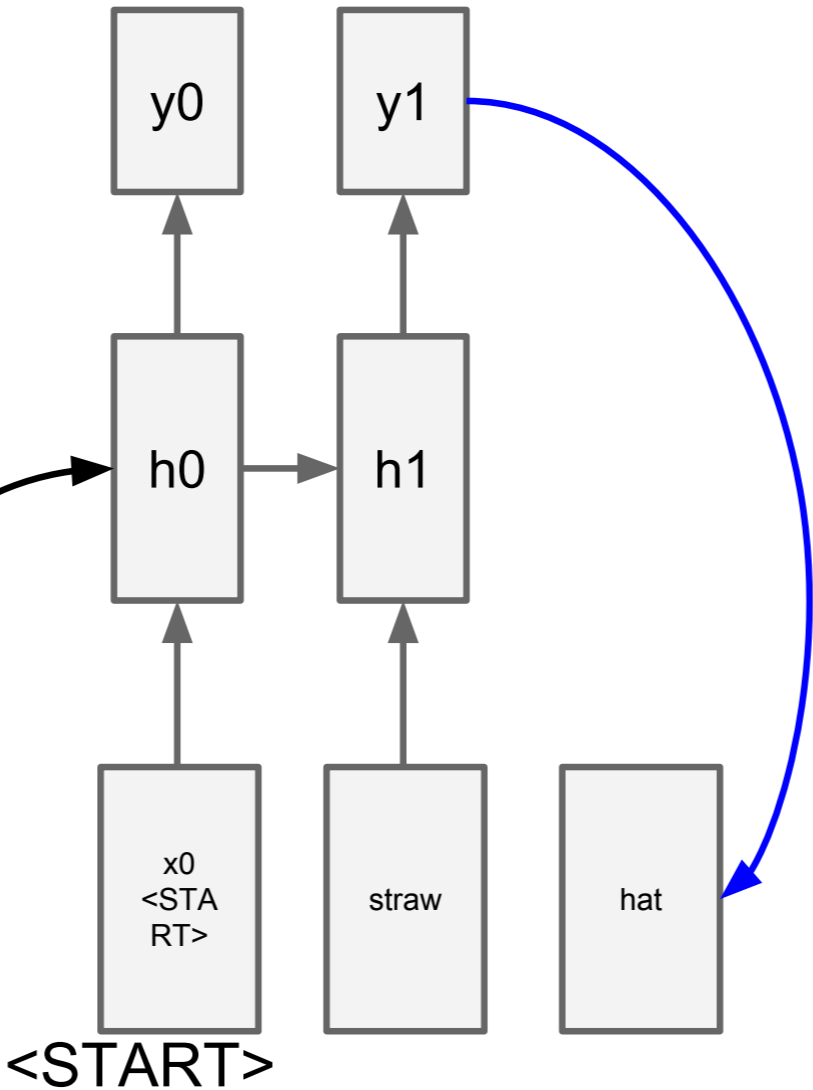

sample!

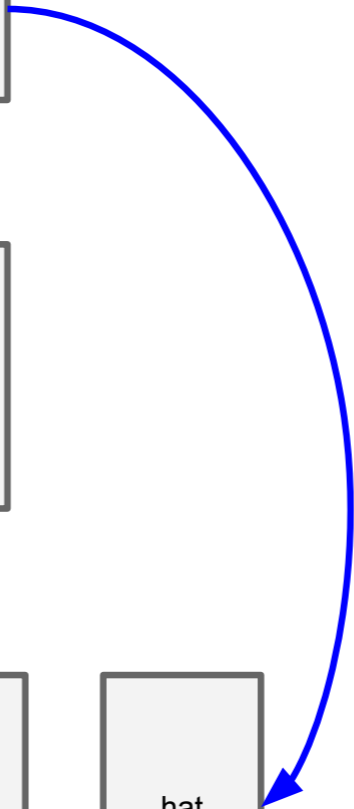
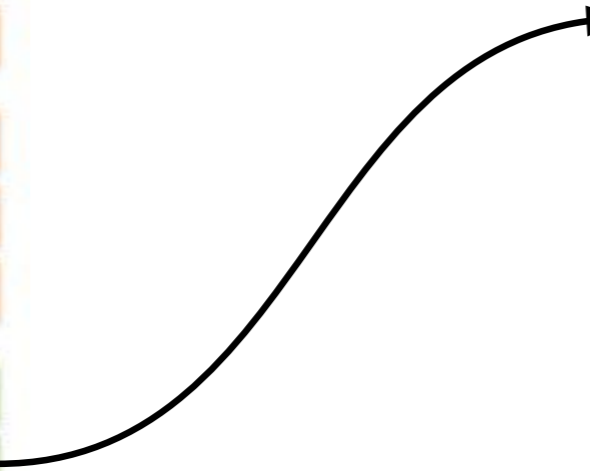



test image

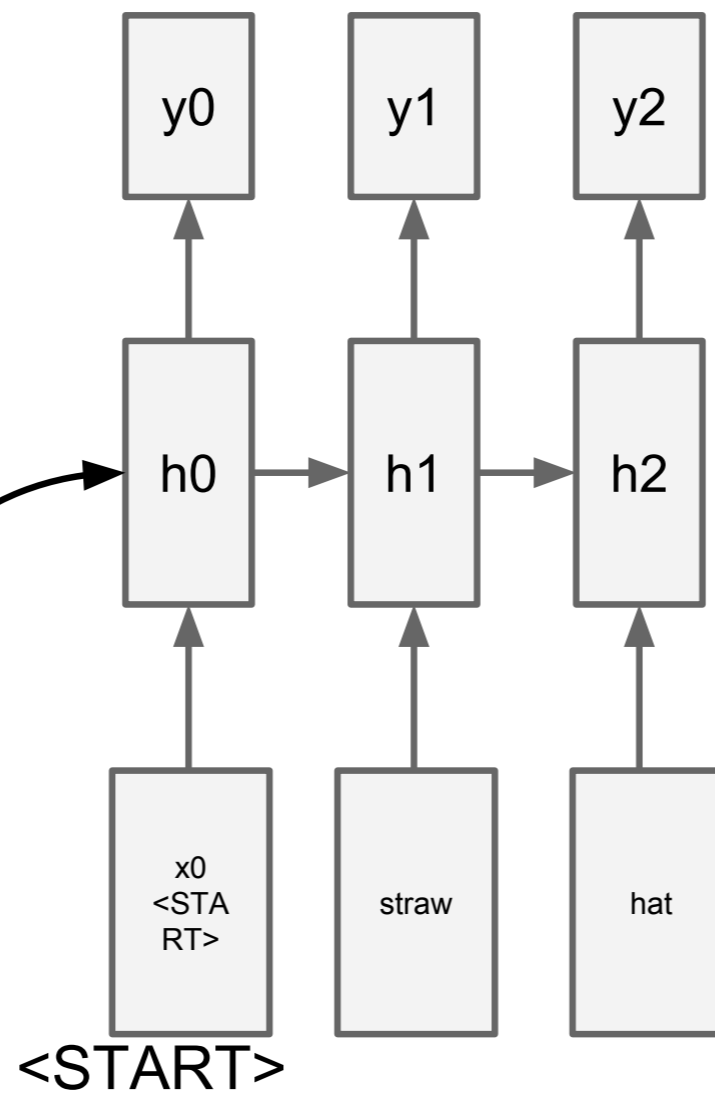



test image

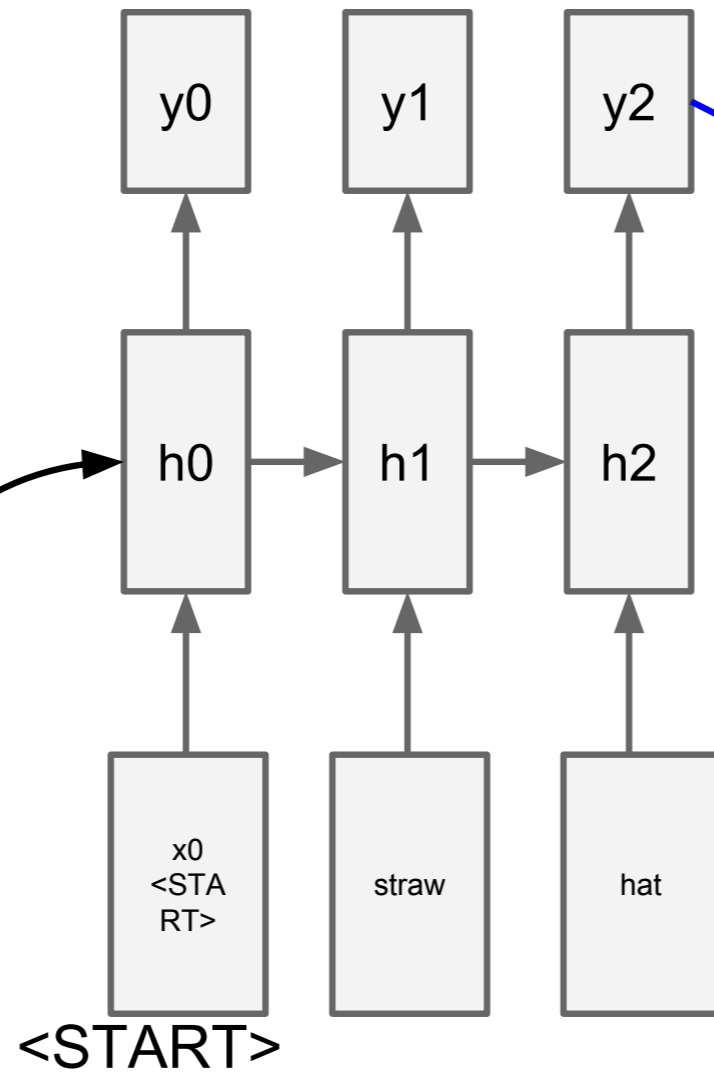

sample
<END> token
=> finish.

Image Captioning: Failure Cases

Captions generated using [neuraltalk2](#)
All images are [CC0 Public domain](#): [fur coat](#), [handstand](#), [spider web](#), [baseball](#)



A woman is holding a cat in her hand

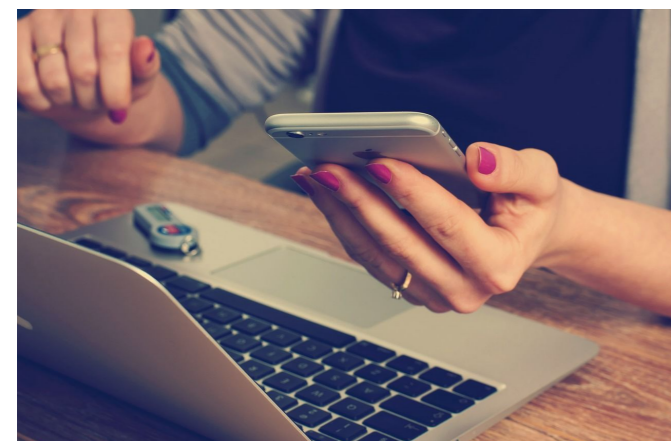

A person holding a computer mouse on a desk

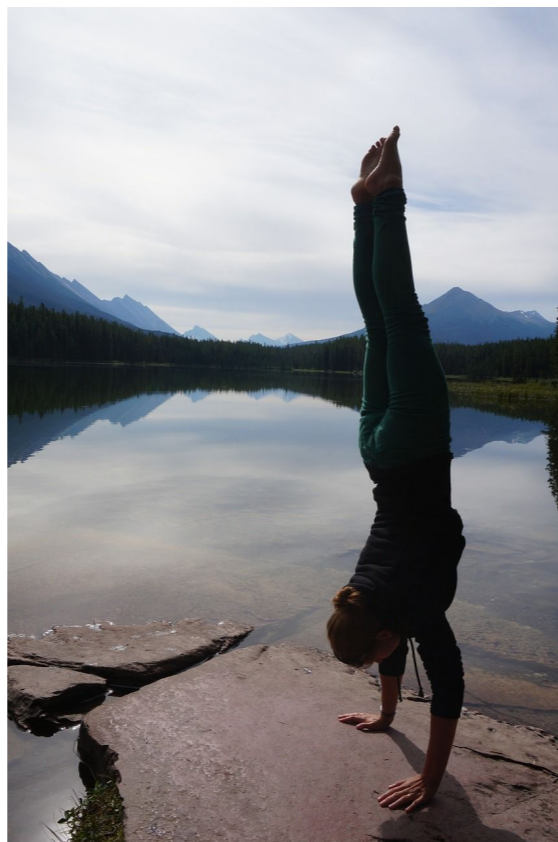

A woman standing on a beach holding a surfboard



A bird is perched on a tree branch



A man in a baseball uniform throwing a ball

Image Captioning with Attention

RNN focuses its attention at a different spatial location when generating each word

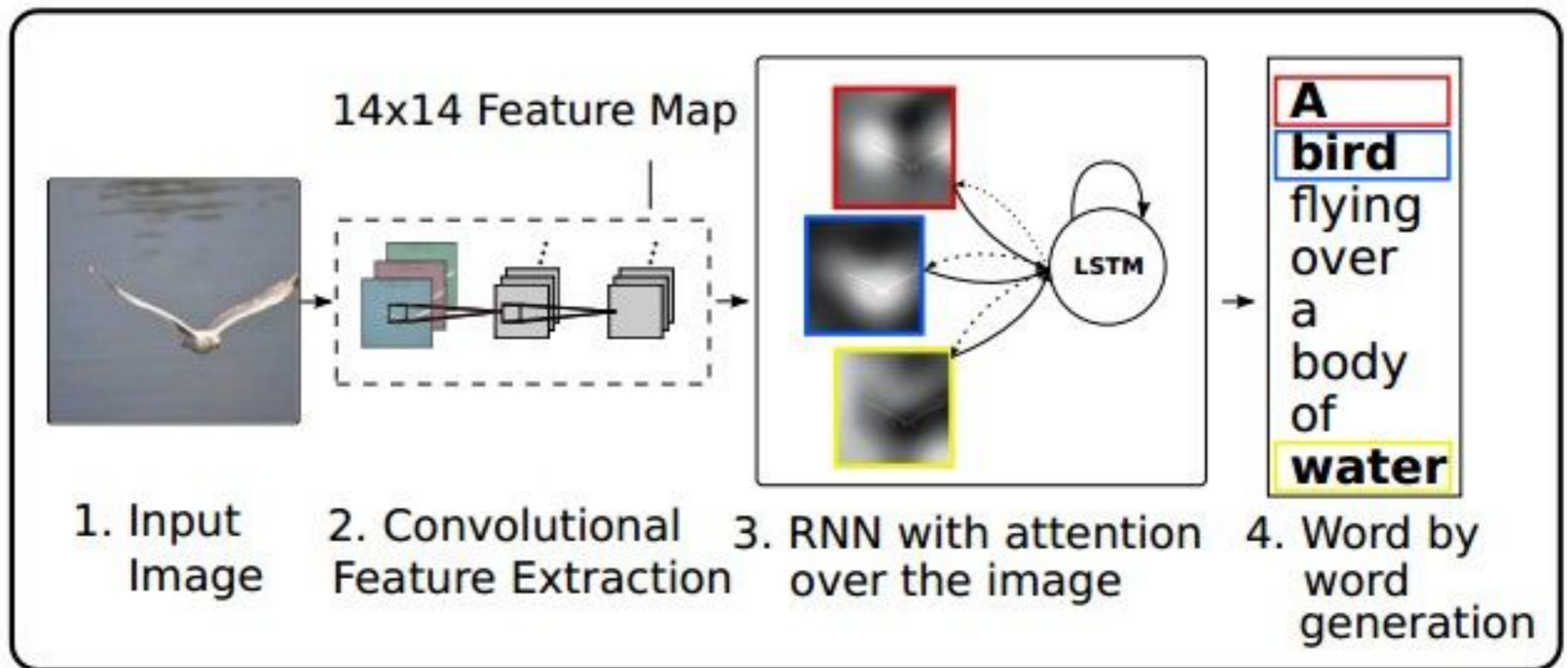

Image Captioning with Attention

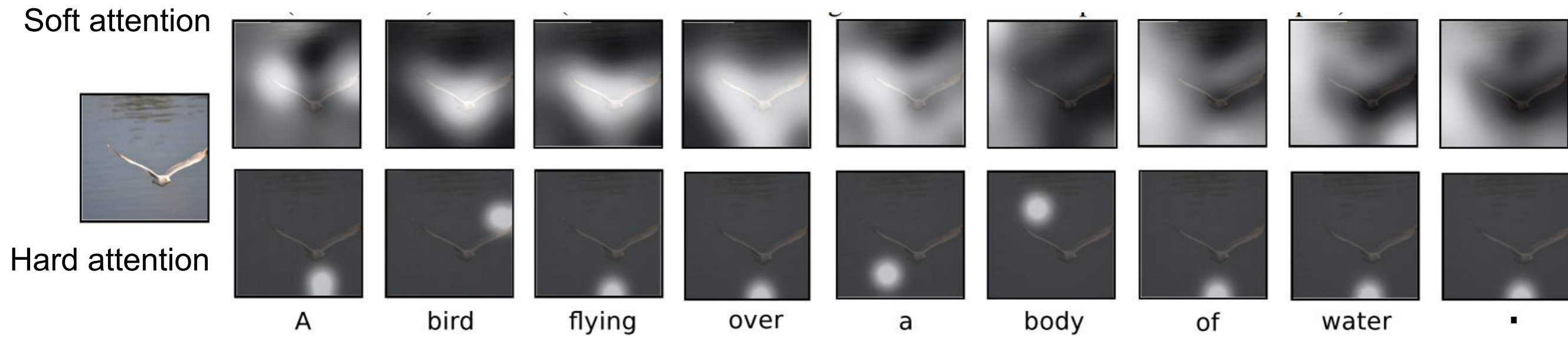
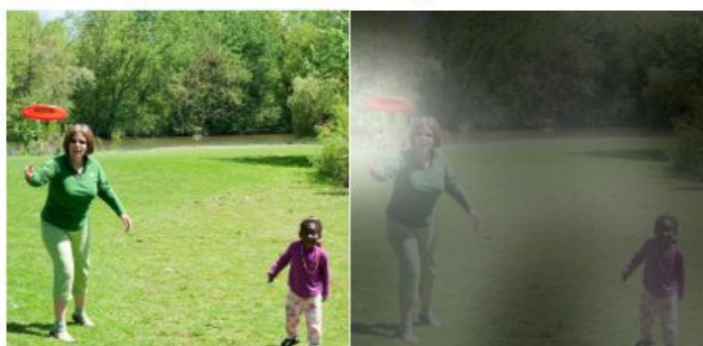

Image Captioning with Attention



A woman is throwing a frisbee in a park.



A dog is standing on a hardwood floor.



A stop sign is on a road with a mountain in the background.

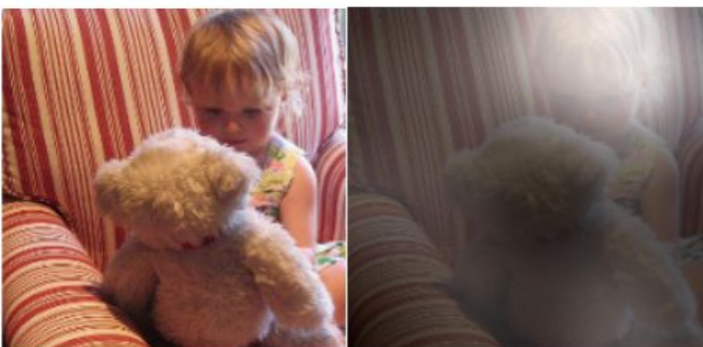

A little girl sitting on a bed with a teddy bear.



A group of people sitting on a boat in the water.



A giraffe standing in a forest with trees in the background.

ViBERT (vision and language BERT)

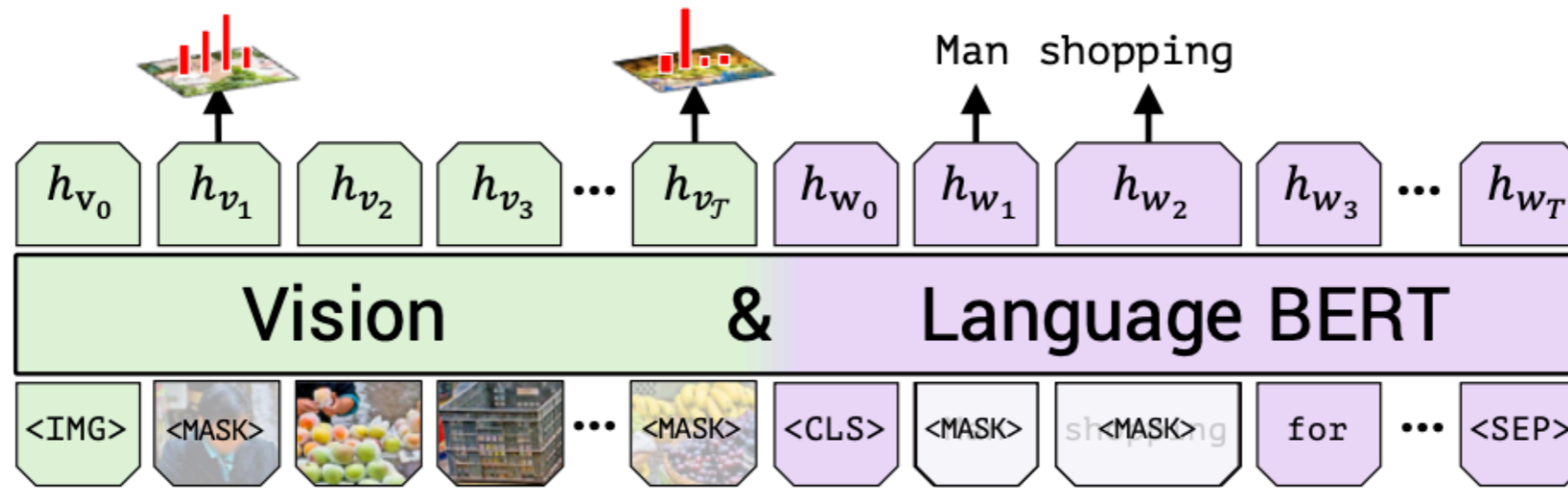

(a) Masked multi-modal learning

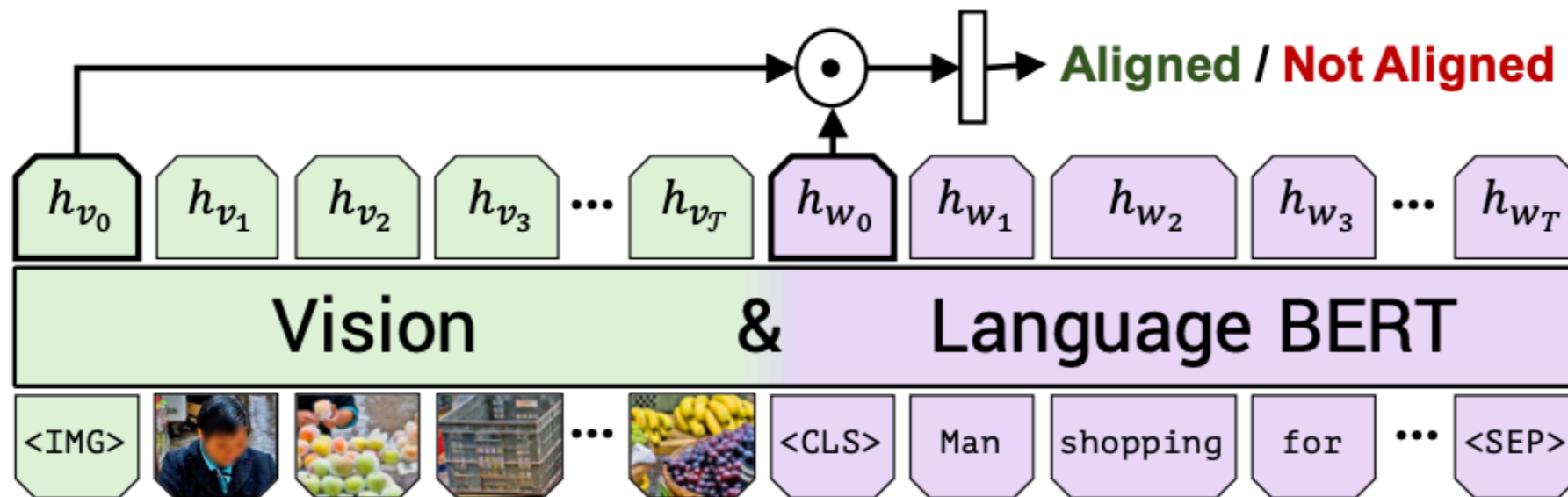

(b) Multi-modal alignment prediction

OpenAI's CLIP: Contrastive language-image pretraining

- ViBERT and similar methods (e.g. LXMERT) rely on small labeled datasets like MSCOCO and Visual Genome (~100K images each)
- OpenAI collect 400 million (image, text) pairs from the web
- Then, they train an image encoder and a text encoder with a simple contrastive loss: given a collection of images and text, predict which (image, text) pairs actually occurred in the dataset

1. Contrastive pre-training

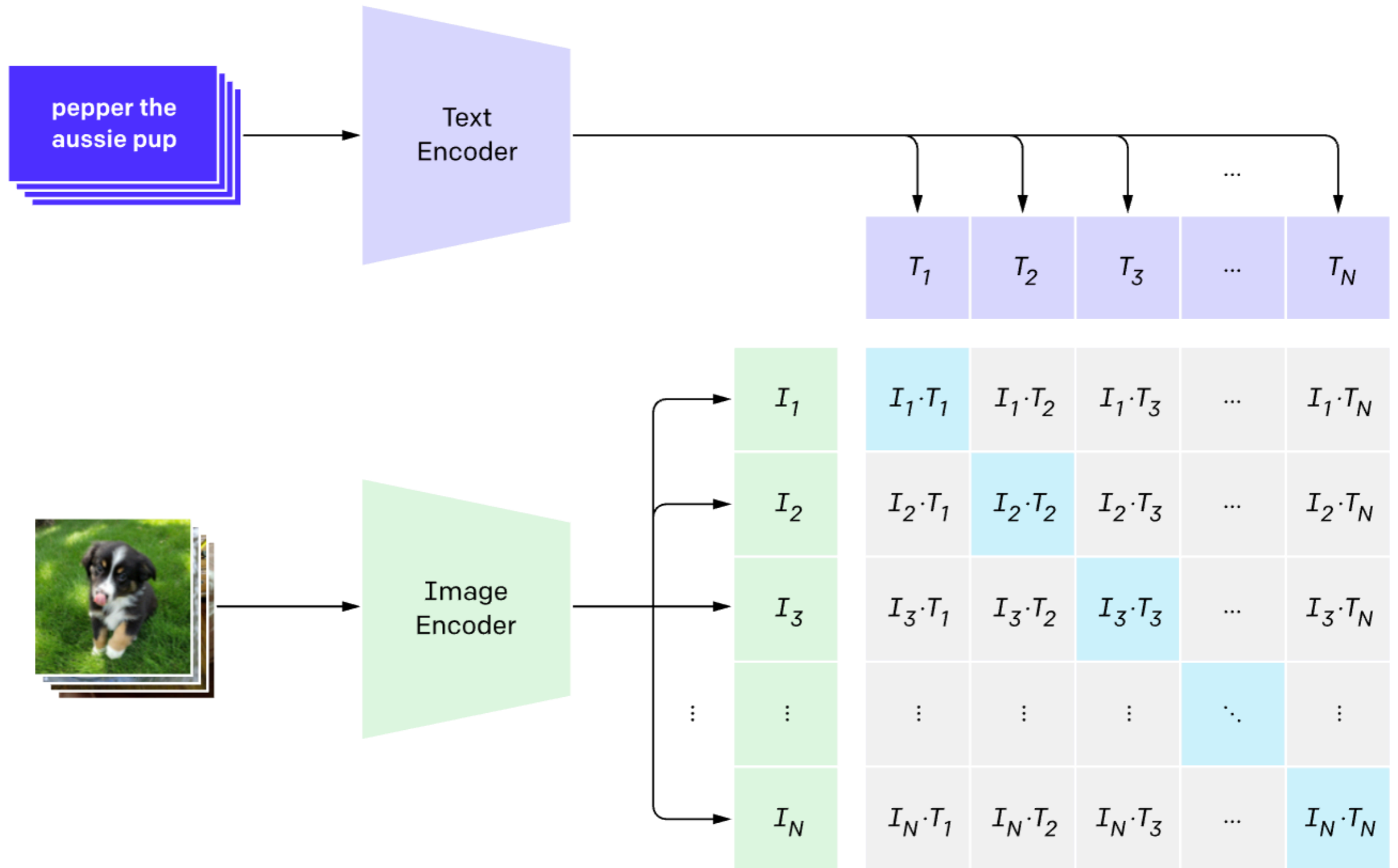





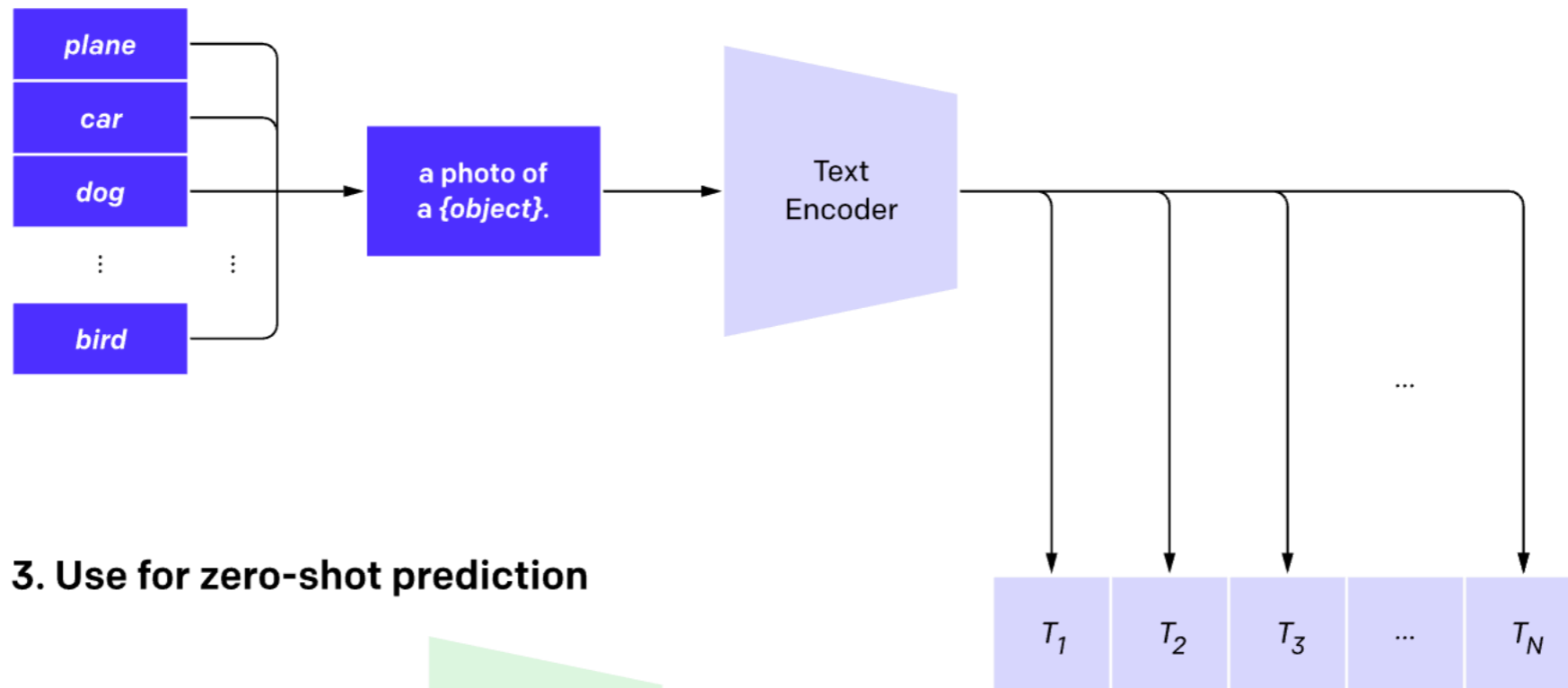

Similar to GPT-3, you can use CLIP for zero-shot learning

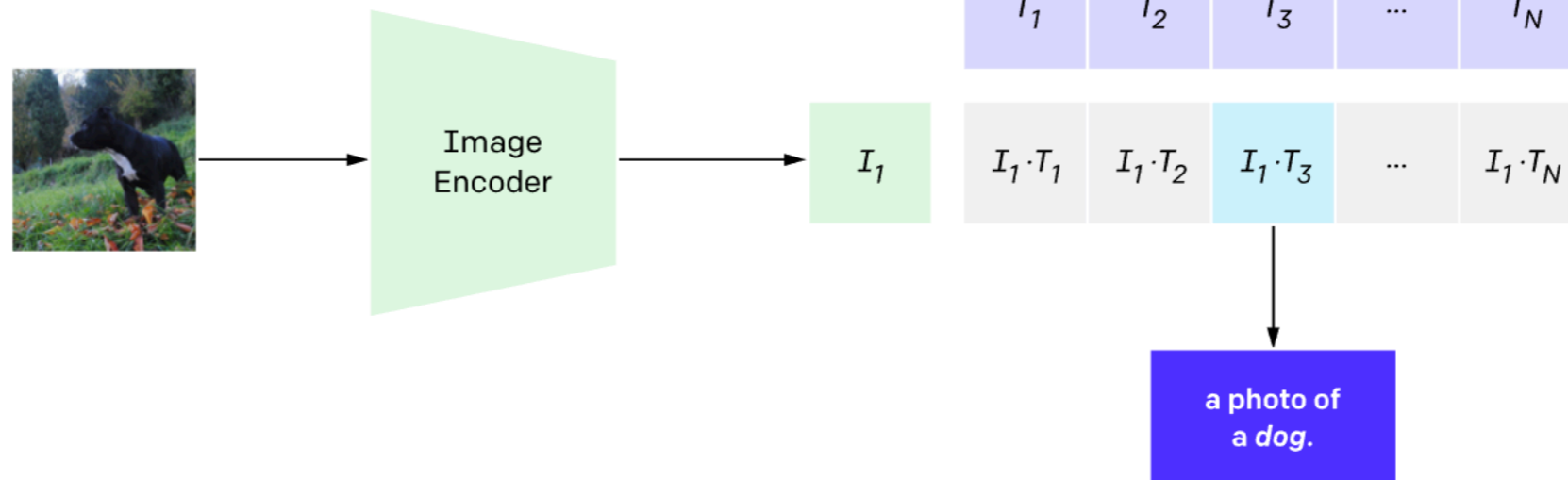
2. Create dataset classifier from label text



3. Use for zero-shot prediction

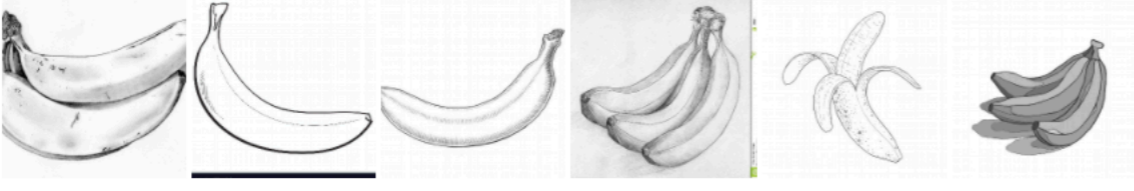

DATASET	IMAGENET RESNET101	CLIP VIT-L
 <p>ImageNet</p>	<p>76.2%</p>	<p>76.2%</p>
 <p>ImageNet V2</p>	<p>64.3%</p>	<p>70.1%</p>
 <p>ImageNet Rendition</p>	<p>37.7%</p>	<p>88.9%</p>
 <p>ObjectNet</p>	<p>32.6%</p>	<p>72.3%</p>
 <p>ImageNet Sketch</p>	<p>25.2%</p>	<p>60.2%</p>
 <p>ImageNet Adversarial</p>	<p>2.7%</p>	<p>77.1%</p>